

Capturing a rebel: modeling the Harley-Davidson brand through a motorcycle shape grammar

Michael J. Pugliese, Jonathan Cagan

Abstract The potential for capturing brand identity within a shape grammar is discussed. A two-dimensional motorcycle shape grammar is presented, along with constraints that associate the resulting designs with the Harley-Davidson brand. Confirmation of the grammar's brand representation is shown through a customer-based survey.

Keywords Shape grammars, Brand, Product design, Motorcycle Harley-Davidson

Introduction

Shape grammars (Stiny 1980) have been used to design buildings and patterns that exemplify various architectural styles (Stiny 1977; Stiny and Mitchell 1978, 1980; Koning and Eizenberg 1981; Knight 1986), to plan the manufacture of a component on a lathe (Brown et al. 1994), and to generate designs of domes (Shea and Cagan 1997), artificial hearts (McCormack, Cagan and Antaki as described in: Cagan 2001), automobile inner hood panels (McCormack and Cagan 2001), coffeemakers (Agarwal and Cagan 1998) and more. These grammars have served as tools for creating new designs that satisfy structural and functional requirements. Few grammars have focused on the generation of consumer products, and none have focused on using shape grammars to establish and maintain product brand characteristics through generated designs. This research examines the feasibility of using shape grammars to capture brand identity and to generate product designs that exemplify elements associated with the core brand.

Few products have come close to establishing such a powerful and unique brand as that of Harley-Davidson. It is this brand identity that has sustained the company and captured the American imagination. This paper will use Harley to explore the representation of brand through constraints upon a more general grammar, as well as the sensitivity of the brand to softening of these constraints. A shape grammar that generates abstracted two-dimensional motorcycle representations and the constraints that capture the essence of Harley have been developed, applied, and tested against customer perception of the Harley-Davidson brand. The focus here upon visual brand image and shape motivates the use of shape grammars over other production systems.

Shape grammars

A shape grammar (Stiny and Gips 1972; Stiny 1980, 1991) is a form of production system (Stiny and Gips 1980; Agarwal and Cagan 2000) that derives designs from successive application of shape transformation rules upon some evolving shape, starting from an initial shape (Stiny 1980, 1991). In particular, given a finite set of shapes (S) and a finite set of labels (L), a finite set of shape rules of the form $\alpha \rightarrow \beta$ transform a labeled shape α in $(S, L)^+$ into a labeled shape β in $(S, L)^0$, where $(S, L)^+$ is the set of all labeled shapes made up of shapes in the set S and symbols in the set L and $(S, L)^0$ is the set that contains, in addition to all of the labeled shapes in the set $(S, L)^+$, the empty labeled shape $\langle S_\phi, \phi \rangle$.

Parametric shape grammars are an extension of shape grammars in which shape rules are defined by filling in the open terms in a general schema. An assignment g that gives specific values to all the variables in α and β determines a shape rule $g(\alpha) \rightarrow g(\beta)$, which can then be applied on a labeled shape to generate a new labeled shape.

Initial exploration of shape grammars by Stiny focused on describing and recreating architectural styles, including Chinese lattice designs (Stiny 1977), Palladio-style villas (Stiny and Mitchell 1978), and Mughul gardens (Stiny and Mitchell 1980). Several others followed, most notably recreating the prairie homes of Frank Lloyd Wright (Koning and Eizenberg 1981). In developing production systems that could both recreate existing models and generate new examples of specific architectural styles, these grammars offered an early indication of the capacity for capturing brand within a shape grammar.

Research soon shifted toward application in engineering design and focused on developing shape grammars that created designs from functional requirements. Cagan

Received: 14 July 2001 / Received: 19 January 2002
Accepted: 20 January 2002 / Published online: 6 April 2002
© Springer-Verlag 2002

M.J. Pugliese, J. Cagan (✉)
Computational Design Laboratory,
Department of Mechanical Engineering,
Carnegie Mellon University,
Pittsburgh, PA 15213, USA
E-mail: cagan@cmu.edu
Tel.: +1-412-2683713

The authors would like to thank Jay McCormack for his detailed comments and suggestions about the grammar and manuscript. Gordon Platto and Craig Vogel shared valuable insights into theories of brand identity and the representation of the Harley-Davidson identity. Jim Dillinger offered both an owner's perspective and the use of his 1994 Harley-Davidson FLHR motorcycle for Figs. 1, 2, 3, 4, 5. The photograph used for these figures is credited to photographer Larry Ripple. The authors would also like to acknowledge the National Science Foundation under grant DMI-9713782 for support of this work.

(2001) contains an extended discussion of engineering applications of shape grammars.

Agarwal and Cagan (1998) presented a shape grammar for the design of coffeemakers that displayed the first use of shape grammars in designing consumer products. Their grammar allowed designers to translate functional requirements into design parameters, using function to constrain a form. Labels and geometry associated with applied rules further related the generated design to the manufacturing parameters and costs necessary for its physical production (Agarwal et al. 1999). This grammar was used to generate new designs as well as to recreate several existing models, including those of Braun, Krups, Black & Decker, and Proctor Silex. The coffeemaker grammar hinted that shape grammars could be used to ensure the satisfaction of product brand characteristics, by identifying certain rule and parameter choices that defined the more expensive coffeemaker brands versus others for the simpler ones. This paper takes the next step, presenting a shape grammar for generating motorcycle representations that may be constrained to capture the identity of the Harley-Davidson brand.

Product brand

Aaker (1996) describes brand identity as "a unique set of brand associations that the brand strategist aspires to create or maintain. These associations represent what brand stands for and imply a promise to customers from the organization members...by generating a value proposition involving functional, emotional or self-expressive benefits." Engineers often believe that brand is left for the marketing people to take care of. Cagan and Vogel (2002), however, argue that the core to a successful brand is the product itself, and thus engineers and designers must be a strong part of the brand creation. They argue that a great advertising campaign cannot create a strong brand around a poor product. On the other hand, although a great product may still take advantage of an innovative, memorable, and costly advertising campaign, the emerging or enduring brand will only succeed if the product itself meets the "needs, wants, and desires" of the customer. Some companies have succeeded with very little advertising and a strong product. Starbucks, for example, spent less than ten million dollars (US) total in advertising in its first ten years of major growth; instead it relied on word of mouth to keep quality standards for its product as part of its core brand message (Schultz and Yang 1997).

The two main challenges are for engineers and stylists to have at their disposal the tools to help understand, articulate, and maintain product brand, and a means for engineers, designers, and brand strategists to have a common platform to discuss the branding of a product. We propose in this work that shape grammars are an approach that can meet these two challenges. This paper takes the first step to explore our thesis by modeling and representing a classic brand identity through constraints in a shape grammar and using that representation to generate products that meet that brand identity. We then explore what features of the brand can be softened before the core identity is lost.

The motorcycle product class

Motorcycles have a sufficiently long product history that allows one to study the evolution of their designs and use as products. Use has undergone a dramatic shift from basic transportation to a form of recreation and a sign of lifestyle and status. This has increased the importance of motorcycle form relative to its performance, yet it remains a complex machine that contains several distinct components exhibiting various levels of technology. It consists of far fewer components than other transportation products, such as automobiles or aircraft, yet is still differentiated by style as with cars. Despite a good deal of diversification, motorcycles share the same basic layout, which suggests the feasibility of a motorcycle grammar.

The components of a motorcycle can be discussed through a simplified look at five main systems: the engine, transmission, wheel, structure, and control. The engine system includes fuel delivery and storage, intake, exhaust, ignition, combustion, and cooling subsystems. There are alternative means of performing each of the subsystem tasks. For example, cooling may involve the use of a radiator, the addition of fins, or the channeling of liquid about the cylinders. Fuel is generally stored within a fuel tank of variable size, shape, and location; however, some extreme-condition racing motorcycles have chosen to channel fuel through their frames. Fuel delivery is generally performed by means of carburetors or electronic fuel injection. Combustion may involve a two or four-stroke process and includes variables concerning the number, size, and orientation of each cylinder, as well as additional ignition and air-management issues. The transmission system includes the clutch, gearbox, and both the primary and final drives. Here the most interesting variable is the means chosen for the drives: shaft, chain, or belt. The wheel system includes the wheels, tires, and brakes. Here the size and type of wheel, generally spoked or cast, offer powerful elements for altering the motorcycle's look and image. The structural system includes the frame (or chassis), the suspension, and the seat. The frame may vary in shape and in the means used to support or suspend the engine. The suspension can vary in the type of front fork used and in the type of connection between the rear wheel and the main body of the frame. The seat varies in size, shape, and orientation, with minor position changes. The control system includes the handlebars, instrument panel, and less-prominent components such as the starter, clutch lever, gear shift, brake levers, and throttle control. A representative sample of the above is used in the grammar.

Evolving consumer preferences for form and image have significantly shaped motorcycle design. Rather than progressing toward a uniform collection of the latest and most technologically advanced components, motorcycles have continued to diverge. Several alternatives were developed for various motorcycle components. Often it was not clear which alternative provided optimal performance, requiring a more subjective selection process. Several manufacturers quickly developed characteristic design preferences that they have since maintained. Certain elements appear so routinely from specific manufacturers that these motorcycle makers are frequently referenced to

explain the design elements. For example, Ducati displays the Desmodromic valve system, the 90-degree “L-shape” engine layout, extensive use of cowlings, and “classic Italian styling.” Another example is the “Boxer” engine layout in which cylinders are opposed, extending transversely outward from the frame; although they were not the first manufacturer to use this layout, BMW has become synonymous with the term “Boxer” in the motorcycle world. The appearance of many manufacturer-specific design elements suggests that certain key component choices could provide sufficient means for identifying a brand among motorcycles.

The Harley mystique

If it is possible for a shape grammar to produce designs that can be associated with a particular brand, it must be possible to do so with products that have the most powerful and well-established brand identities. A study of motorcycle brands quickly reveals that authors and owners hold Harley-Davidson in a unique light, with great respect and distinction. The name alone conjures up a mythical image of power, rebellion, and classic style in any American that hears it as well as many people worldwide, witnessing to the strength of the Harley-Davidson brand.

Harleys offer a more powerful look, sound, and feel; they tend to use more traditional components, such as belt drives and carburetors with air-cooling and no cowling. They have chosen to retain many characteristic design elements over time in an effort to maintain the purity of their brand. These design elements, the similarity across its models relative to that of other manufacturers, and the legendary image that Harley-Davidson continues to hold suggest that Harley is a strong candidate for modeling within a shape grammar.

Anatomy of a Harley

Much of the rebellious spirit associated with the brand, the motorcycles, and their riders may be a state of mind that offers both a sense of natural freedom and of brotherhood with other Harley owners around the world. Some of this may come from the motorcyclist’s intimate connection with the open road and the surrounding environment. Much of it may be a result of the 1947 Hollister Riots in California, the subsequent press coverage, and movies such as *The Wild One* and *Easy Rider*, which portrayed motorcyclists as large, tough, and dangerous outlaws clad in black leather and tattoos. Although the rebellious image was at first discouraged and downplayed, the company later learned to embrace it. Today, a more peaceful image has replaced that of the outlaw; however, the brand still retains its sense of freedom, power, and brotherhood.

Although the rebellious spirit cannot be quantified nor the sound visually represented, the style (Fig. 1) – a raw, tough, and powerful mechanical look – of the Harley-Davidson motorcycle can be broken down, defined, and replicated. The ability to mimic the Harley look has been demonstrated repeatedly by large numbers of competitor motorcycles. For example, compare the 2002 Yamaha Midnight Star and Honda Shadow series with Harley’s 2000 FLSTF Fat Boy. The engine, fuel tank, seat, headlight, and even fenders bear dramatic resemblance. We have identi-

fied what we believe to be the critical visual elements that establish the core of the Harley brand. This brand identity may be coded within a shape grammar by incorporating the critical visual elements into constraints upon the rules and parameters of a more general motorcycle grammar.

At the heart of every Harley-Davidson motorcycle is a 45-degree V-twin four-stroke engine – never covered by cowling, fuel tank, or added ornamentation; an elliptical air filter occupies the empty space between cylinders, but never obstructs their view (Fig. 2). The centerline between cylinders is vertical, with each cylinder canted 22.5 degrees away from it – one pitched forward, the other back. The engines use a single crankshaft, which can generally be recognized by a circular cap visible at the base of the frame and in line with the centerline of the V. This configuration has provided so much more than an enduring visual element, as it yields both the characteristic sound and thumping feel that have made the motorcycle legendary. Unlike many competitor motorcycles, Harleys do not use radiators, which would hide the engine (when viewed from the front), but rely upon natural air cooling. Traditional components are often retained, such as belts for power transmission and carburetors for fuel delivery (although fuel injection is now used on select models).

The powerful engine is always shown off in a long, low, rigid-style cradle frame. The frame suggests power and speed. A profile of the frame exhibits a low and unadorned rear section. The much more prominent forward section is high, wide, and robust; it presents a sense of power and muscle that is carried through in the engine and fuel tank attached to it. As seen in Fig. 3, the frame resembles a scalene triangle with a small rear angle and a forward-leaning

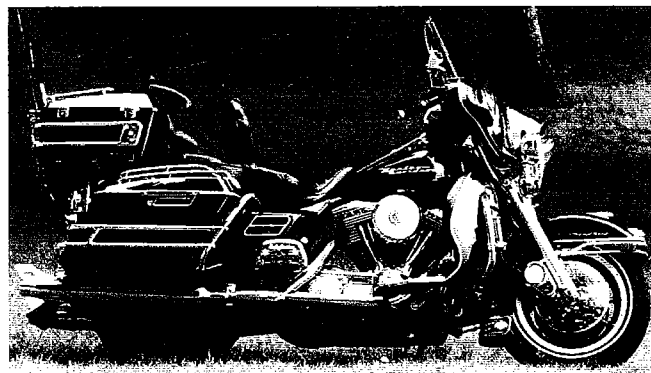

Fig. 1. A Harley-Davidson motorcycle

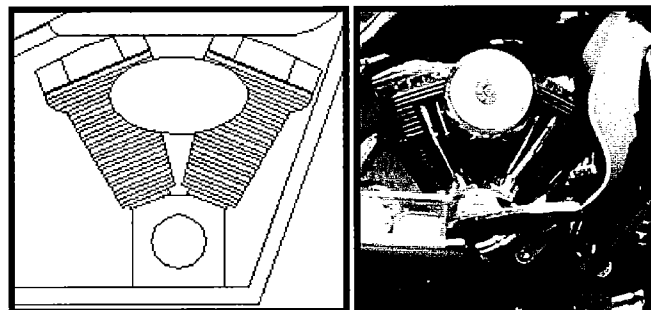

Fig. 2. The famous 45-degree V-twin engine

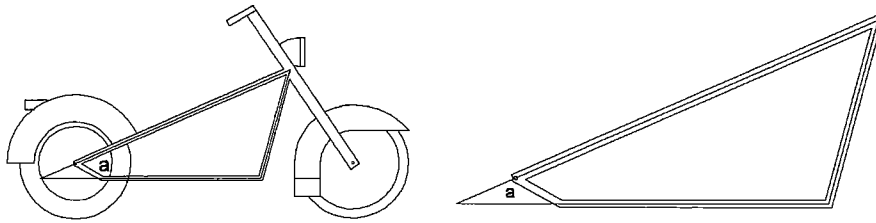

Fig. 3. Low, triangular cradle frame

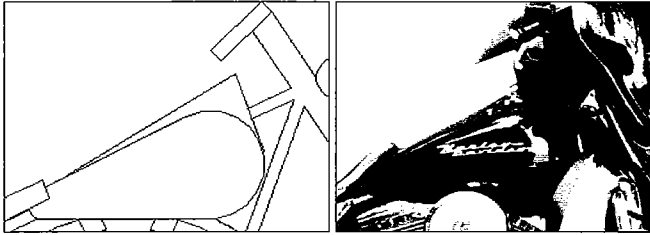

Fig. 4. Teardrop fuel tank and triangular instrument panel

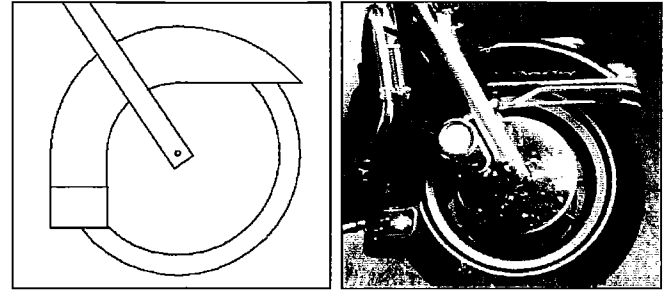

Fig. 5. Classic Harley-Davidson front fender treatment

segment to the right. This characteristic frame can be seen in one of two styles, the “softtail” or “hardtail”; however, the hardtail holds a stronger connection with the brand. The wheelbase is typically long, especially in models more faithful to brand. The front fork, fenders, and tires, along with the unique frame, all establish a sense of robustness and power through the use of wider, thicker dimensions.

Riding along the powerful frame, Harley-Davidsons use a classic teardrop-shaped fuel tank that is critical to the brand. The lower edge of the teardrop is horizontal, aligning with the upper edge of the engine – never hiding the cylinders nor revealing a significant gap (Fig. 4). Behind the fuel tank lies a seat that tightly hugs the motorcycle frame, often exhibiting an ergonomically cupped shape. The shape, orientation, and surface lines of the seat help accentuate the low, angled look of the frame. Ahead of the fuel tank rests an elliptical, or domed, chrome headlight.

Harley-Davidson motorcycles use large wheels that are generally spoked, not cast. The rear wheels are stereotypically smaller in diameter than the front, although some models use the same diameter for both. Thick high-profile tires are generally used, with an often much thicker tire to the rear. Fenders always overlap the tires so that they do not reveal a vacant gap. Although many varieties of fender are common on Harley-Davidsons, there is one style of front fender that is very strongly associated with the brand (Fig. 5). This front fender shape resembles the lowercase letter “r,” with a rectangular rear edge and a curved upper surface that meets a flat edge above the front axle hub.

The most critical elements are the 45-degree engine, the overall low, triangular-looking frame, and the teardrop-shaped fuel tank. Certain front and rear fender treatments, a large triangular-profiled instrument panel above the fuel tank (Fig. 4), thick casting around the headlight, and other features offer additional elements that are strongly associated with the Harley-Davidson brand. Although these features do not appear on the majority of Harley-Davidsons, they further distinguish a motorcycle as a Harley. Push rods and certain exhaust pipe layouts are tertiary features of the brand, purposely excluded from our discussion to maintain a higher level of abstraction.

The motorcycle grammar

This research explores the feasibility of capturing and representing brand within a shape grammar and uses that representation to explore the sensitivity of brand to minor and major variations. Our focus is on Harleys, but we begin by developing a general motorcycle grammar capable of generating a broad but restricted set of motorcycle types. It does not, however, generate only Harley-Davidson models. In addition, add-on part features such as fairings, cowlings, saddlebags, additional seats, and other accessories have not been included. The grammar can readily be extended to include an even broader class of motorcycles or set of features.

The motorcycle shape grammar consists of a set of 45 parametric rules that create an abstracted profile view of a motorcycle, in a two-dimensional Cartesian coordinate plane as presented in Figs. 6, 7, 8, 9, 10, 11. Although these rules have not yet been coded for computer implementation, they enable manual application as carried out here. The grammar starts with an empty space, adding components as rules are applied. To ensure that the proper number and assortment of components are added, labels are used to regulate the designer’s rule selection. Each rule adds, eliminates, or replaces the labels assigned to a developing design such that it regulates which rules may be applied next.

Rules allow for the description of several key components, such as:

1. wheelbase;
2. wheel size;
3. tire size and thickness;
4. fender shape, size, and orientation;
5. frame type (rigid, soft, or stressed);
6. crankshaft size, shape, and position;
7. cylinder number and orientation;
8. air filter shape and size;
9. fuel tank size, shape, and position;

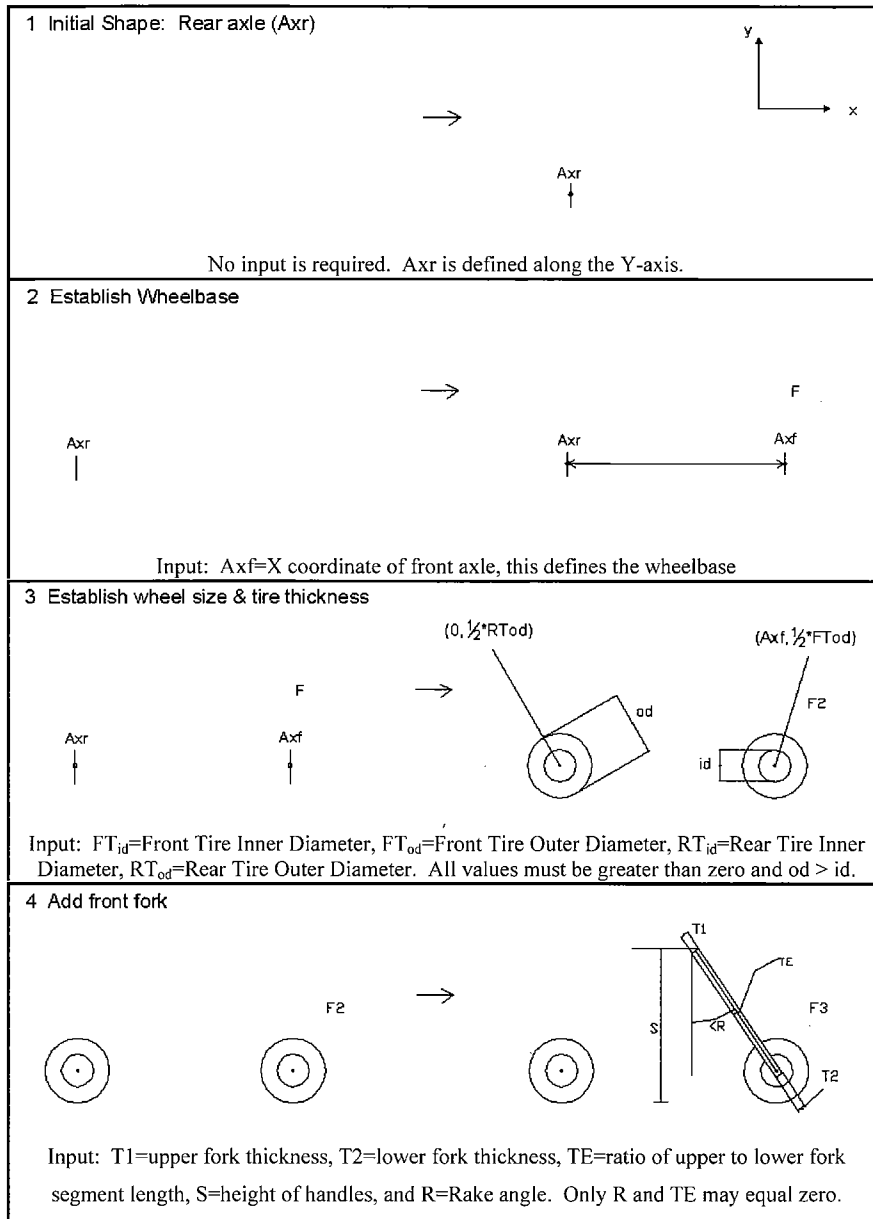

Fig. 6. Rules 1-4 establish wheelbase, wheels, and tires

- 10. fuel cap and instrument panel;
- 11. seat;
- 12. handlebar;
- 13. headlight;
- 14. taillight.

The first four rules must be applied in all designs, and establish the wheels, tires, and front fork (Fig. 6). Rule 2 allows the user to define the wheelbase. Rule 3 creates the wheels and tires based on four dimensions given by the designer. Rule 4 allows the designer to create various types of front fork, to define the rake angle, and to set the position of the handlebar.

Rules 5 through 16 deal with formation of the motorcycle's frame (Fig. 7). Rule 5 offers the designer's first opportunity to select a rule for application, as the designer may opt to use rule 5 or rule 14 to begin construction of the frame. Rule 14 is the first step in the

series of rules 14-16, which create a stressed frame, such as those used in many dirt bikes. The stressed frame suspends its engine from elements that lie above it. Rule 5 is the first step in creating either a "hard" or "soft" style cradle frame, which can then be carried out with one of the series of rules 6-8 or 9-13, respectively. Cradle frames have elements that lie below the engine and extend toward the front fork, wrapping around the engine to support and hold it in place. Both types support the engine; however they differ in rear suspension and construction. Soft frames have a swing arm connecting the rear wheel to the frame downtube, whereas the hard, or "hardtail," frame has its downtube directly mounted to the rear wheel hub.

Rules 17 through 19 allow the designer to create an engine profile (Fig. 8). The designer defines the dimensions of the crankshaft housing with rule 17. Rule 18 determines the number of cylinders, their height and

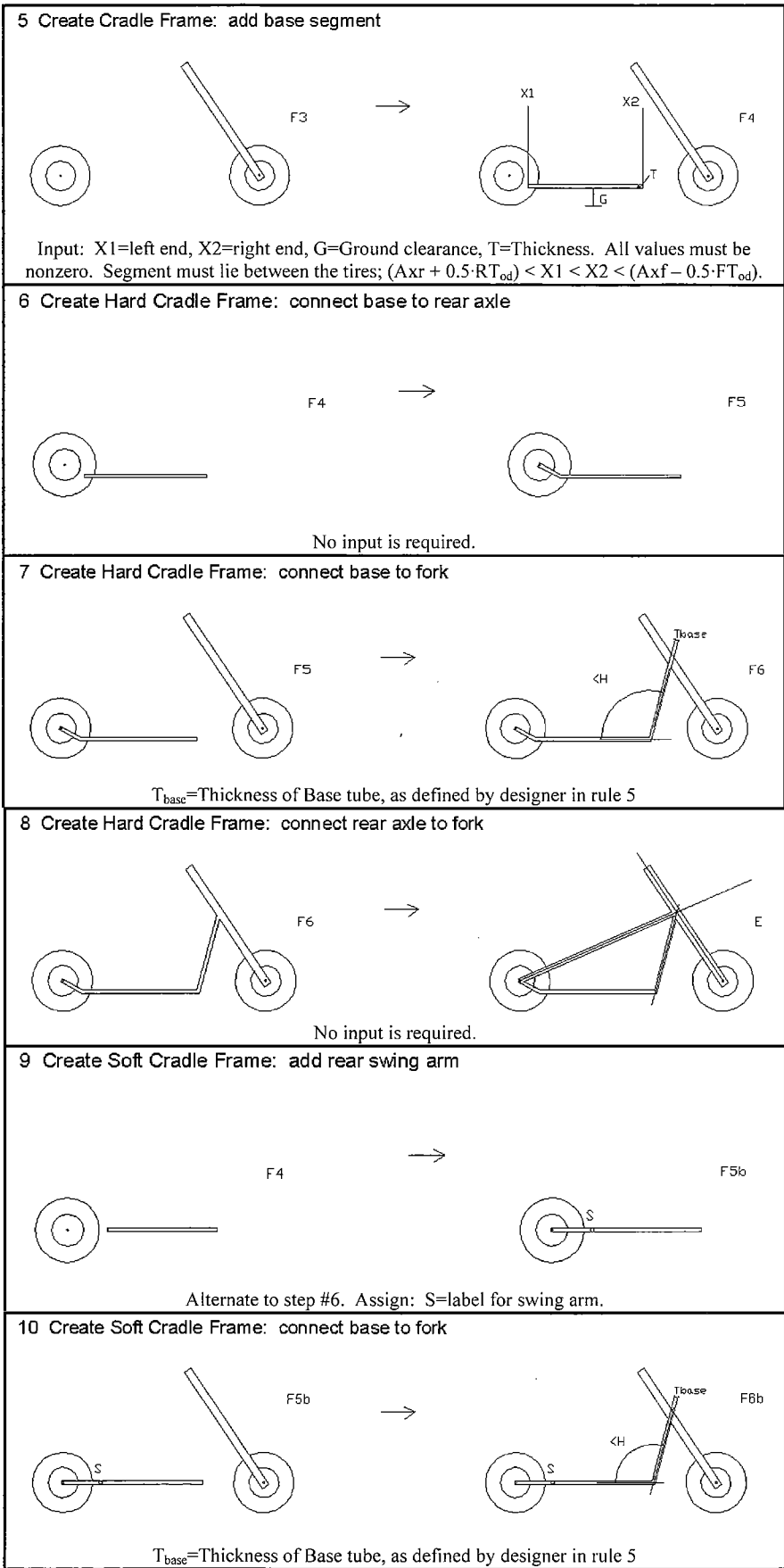

Fig. 7. Rules 5–16 establish the frame

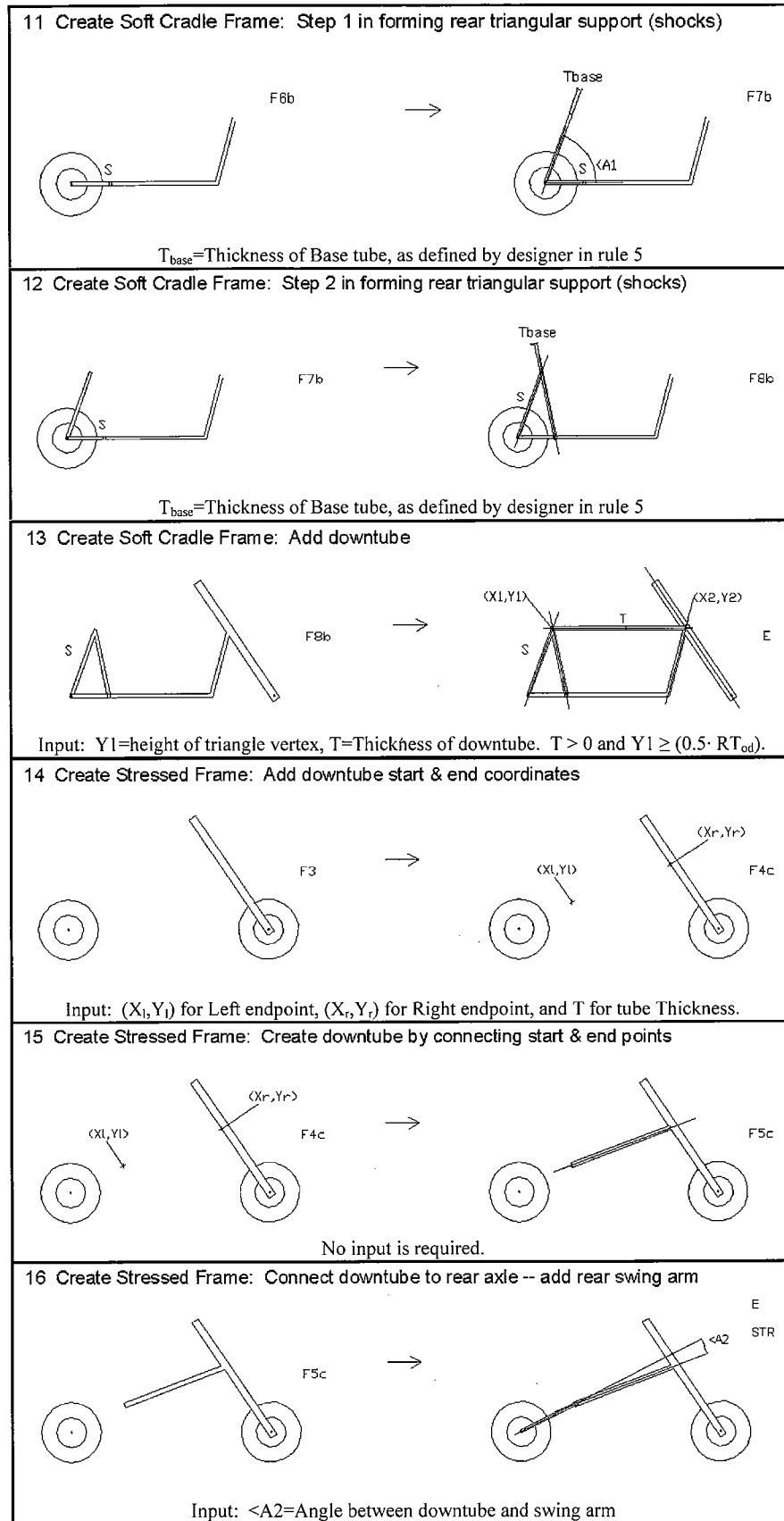

Fig. 7. (Continued)

width, and defines the orientation of both the housing and cylinder(s) with respect to the motorcycle frame through a choice of coordinates. Rule 19 is used for a

stressed frame to support the engine. Air filters are added later in rules 43 through 45 as a means to terminate the grammar.

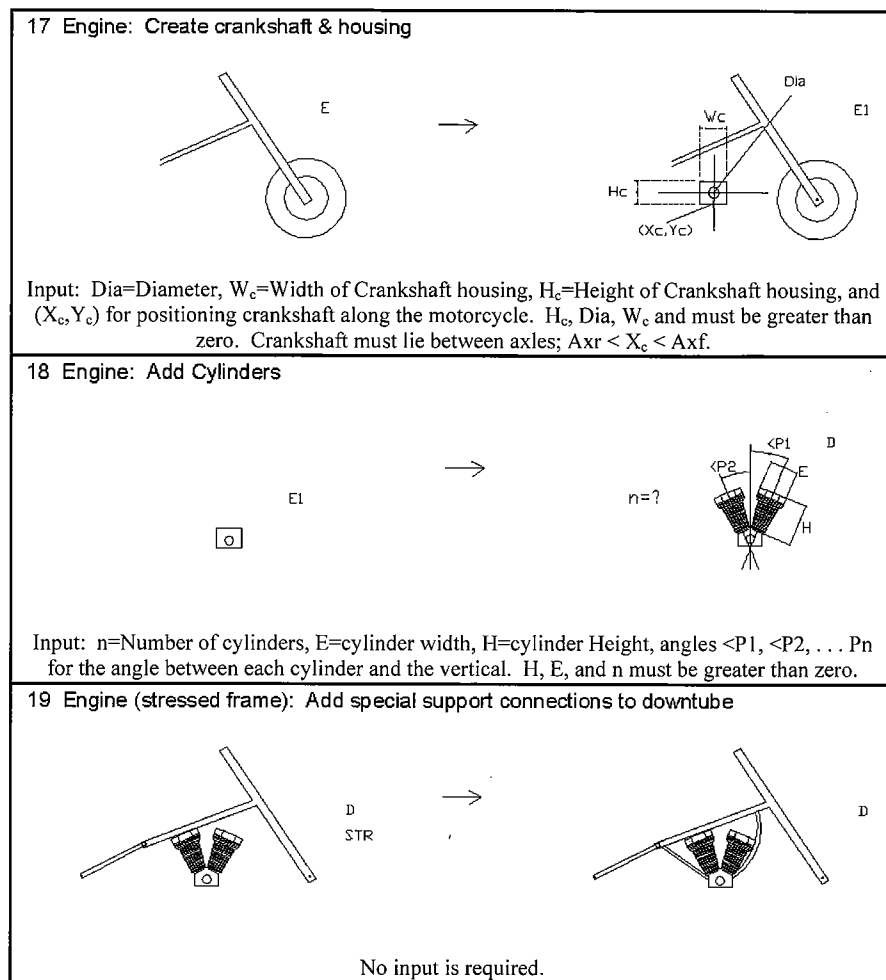

Fig. 8. Rules 17–19 create an engine profile

The next set of rules (Fig. 9) creates the fuel tank and gauges. Rules 20 and 21 create the fuel tank outline from the coordinates of six points as defined by the designer. Rule 22 allows for rotation of the fuel tank; this optional rule reorients a previously defined tank shape to create a new look. At this point, the grammar offers the choice of adding an instrument panel (with rules 23 and 24), or a speedometer or fuel cap (with rules 25 and 26).

The front and rear fenders are designed using rules 27 through 35 (Fig. 10). Rules 27, 28, and 29 establish the basic fender dimensions, and must be applied in all designs. The grammar then offers four unique rule combinations to alter the fenders before completing their design.

The seat and handle bars are designed next (Fig. 11). Rules 36 and 37 create the seat through the definition of ten points. The designer defines the coordinates of these ten points, such that at least two points contact the surface of the motorcycle. Both rules must be applied in all designs. Rule 38 requires the designer to specify the dimensions and orientation of the visible handlebar.

Rules 39 through 42 add a headlight and taillight (Fig. 12). For the headlight, the designer may choose to apply either rule 39, creating a semielliptical profile, or rule 40 for a rectangular profile. Rule 41 creates a rectangular-profiled taillight using the location and dimensions defined by the designer. The component boundaries are clarified through application of rule 42, which removes

overlaps created in mounting the lights upon the motorcycle.

Three versions of the termination rule remain, which prevents further rule application and finalizes a design (Fig. 13). Rule 45 simply ends the design process by eliminating the remaining label, whereas rules 43 and 44 also add an elliptical or polygonal air filter, respectively.

Applying the grammar to create a dirt bike motorcycle

Following is an example demonstrating how the previously described rules can be applied to produce a two-dimensional representation of a motorcycle that captures features of a typical (non-Harley) dirt bike.

Application always begins with rule 1, recognizing a blank initial space and adding a rear axle designation marker. Application of rule 2 defines the wheelbase, by defining the X -position of the front axle. Rule 3 defines the wheel sizes and inner and outer diameters of the tires (Fig. 14). Circles, representing the axle hubs, replace the axle markers. These hubs, wheels, and tires are drawn such that the lower outer tire edges of both the front and rear are tangent to the line that designates the ground surface.

The application of rule 4 must follow, creating a front fork at the specified rake angle, thickness, and handlebar height from the ground (Fig. 15). This rule allows for the generation of various fork styles (telescopic, inverted,

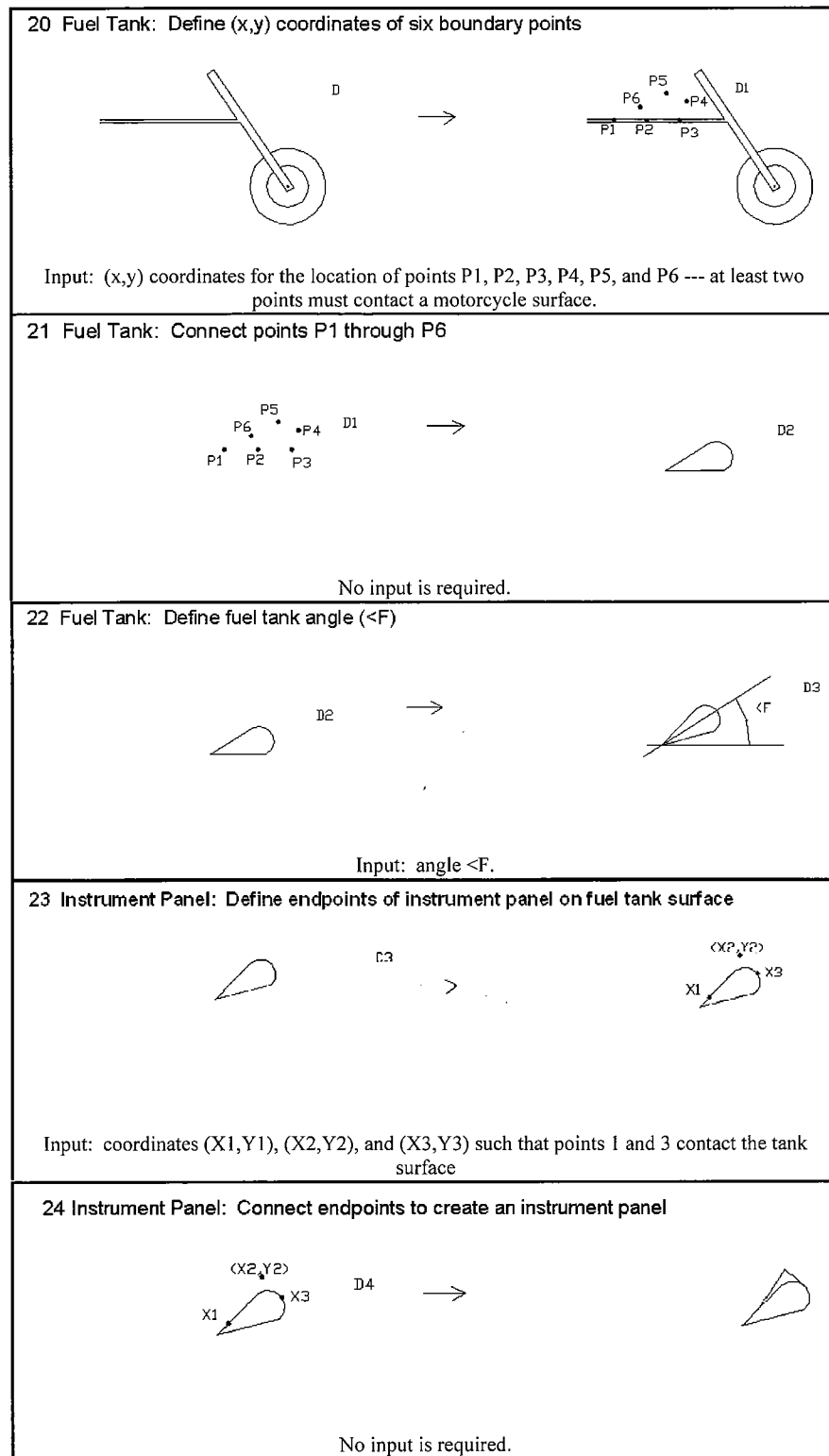

Fig. 9. Rules 20–26 establish the fuel tank and instrument gauge/panel

etc.) by allowing the designer to define the thickness and relative length of two unique fork segments. The designer assigns a value for the ratio between the upper and lower segment lengths such that a one-part fork is created.

This example now applies rule 14 to initiate the construction of a stressed frame. Rules 14 and 15 create a downtube. Rule 16 is applied to add a rear swing arm, connecting the rear axle to the downtube (Fig. 16).

The next rule that may be applied is rule 17, which creates the profile of a crankshaft housing. The designer specifies the width and height of the housing, and the diameter of the crankshaft cap. The designer positions the crankshaft housing along the frame's base segment. Next, rule 18 creates the engine cylinders. The rule allows the designer to define the width, height, number, and orientation of cylinders. This example uses parameter values

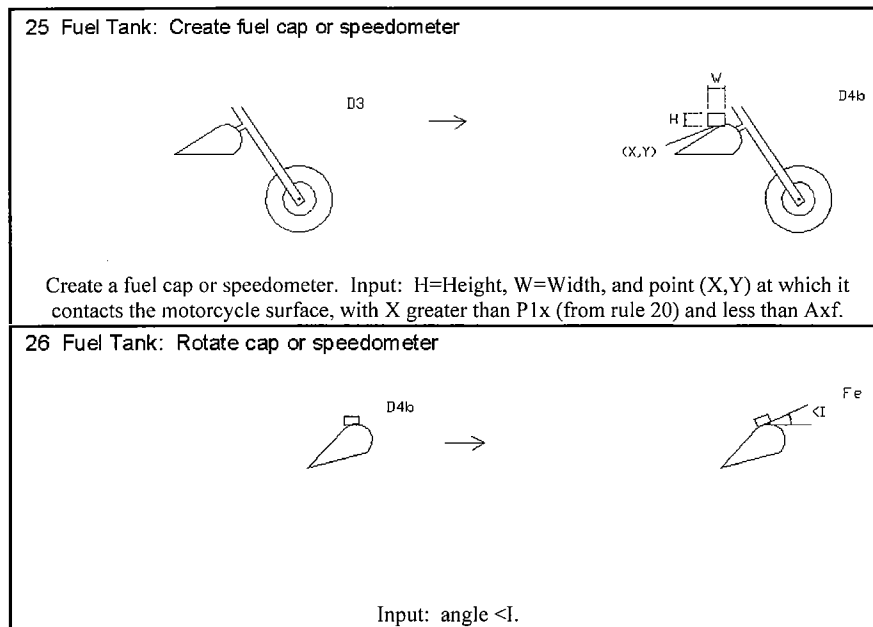

Fig. 9. (Continued)

that produce a forward-canted one-cylinder engine configuration. Rule 19 is applied to add the support elements, which suspend the engine from the frame (Fig. 17).

Next, rule 20 is applied to plot points that define a uniquely shaped fuel tank boundary. Rule 21 connects these boundary points to draw the fuel tank. Rule 22, which allows the designer to rotate the fuel tank, is applied to finish its design. The grammar now offers the option of adding an instrument panel (rule 23), or a fuel cap or a speedometer gauge (rule 25). In this example, rule 25 is applied to create a fuel cap that does not alter the motorcycle profile. Parameters are chosen for width, height, and mounting point, such that the cap profile is not visible. Next, rule 26 allows for the rotation of the fuel cap and completes its design (Fig. 18).

Rule 27 is applied to create the front and rear fenders. The rule asks the designer to define the following parameters: rear inner and outer radius, front inner and outer radius, and the orientation of each fender edge. Parameter values are chosen to create a raised front fender and to eliminate the rear fender. Next, rule 28 is applied to draw the outline of the front fender by sweeping an arc through the orientation angles and radii defined in rule 27. Rule 29 clarifies the separation between the fenders and other components. Now the grammar allows for the application of rules 34, 32, or the series of rules that begin with 30. Here, rule 34 is applied to finalize the fender design with a label conversion (Fig. 19).

Rule 36 plots ten points to define the seat outline. These points are connected with arcs and lines by rule 37 to draw the seat. Rule 38 creates a rectangular handlebar given a width, height, and angle of orientation from the horizontal (Fig. 20).

The grammar now calls for application of either rule 39 or 40 to create a headlight. This example applies rule 40 and specifies a lack of headlight by assigning dimensions of zero for the light. Rule 41 must now be applied to add a taillight using two dimensions and a mounting point;

however, this model makes use of the rule to specify a lack of taillight. Rule 42 follows to clarify the boundaries of the taillight and headlight from surrounding components, eliminating any resulting overlaps (Fig. 21).

The final design decision is whether to apply an air filter. The grammar allows for application of either rules 43 or 44 to add an air filter or rule 45 to complete the design without one. Here rule 45 is applied to complete the design without adding an air filter. The final design is shown in Fig. 22.

Constraining a Harley

The visual elements that characterize the Harley brand (as described earlier) may be translated into constraints upon rule application and parameter values. Application of these constraints ensures that the grammar will produce motorcycles that are visually representative of the Harley-Davidson brand:

- Engine: 45-degree V-twin, vertical centerline, elliptical air filter:
 - Rule 17: $0.5 \times Axf \leq X_c \leq X2$ (from rule 5);
 - Rule 17: $Y_c = G + T_{base}$ (parameters G and T from rule 5);
 - Rule 18: $n=2$, $P1=-22.5$, $P2=22.5$, $H>E$;
 - Rule 43: Applied to create an elliptical air filter.
- Frame: Cradle frame, low rear, long wheelbase:
 - Rule 2: $62 \leq Axf \leq 70$;
 - Rule 4: $25 \leq R \leq 45$, $T1 \geq T_{base}$, $T2 \geq T_{base}$;
 - Rule 5: Must be applied for cradle frame;
 - Rule 5: $(0.5 \times RT_{id}) \leq X1 \leq (0.5 \times RT_{od} + 6)$;
 - Rule 5: $(0.5 \times Axf) \leq X2 \leq (Axf - 0.5 \times FT_{od})$;
 - Rule 6 or rule 9: Applied;
 - (If rule 9) Rule 13: $\arctan[\Delta Y/\Delta X] \geq 18$ degrees;
 - Rule 7 or 10: $95 \leq R \leq 115$.
- Fuel tank: Teardrop shape, horizontal lower edge, triangular instrument panel:
 - Rule 20: $P1_y \leq P2_y \leq P3_y$; $P1$, $P5$, $P6$ collinear;
 - Rule 20: Lines $P1-P3$ and $P1-P6$ form an acute angle;

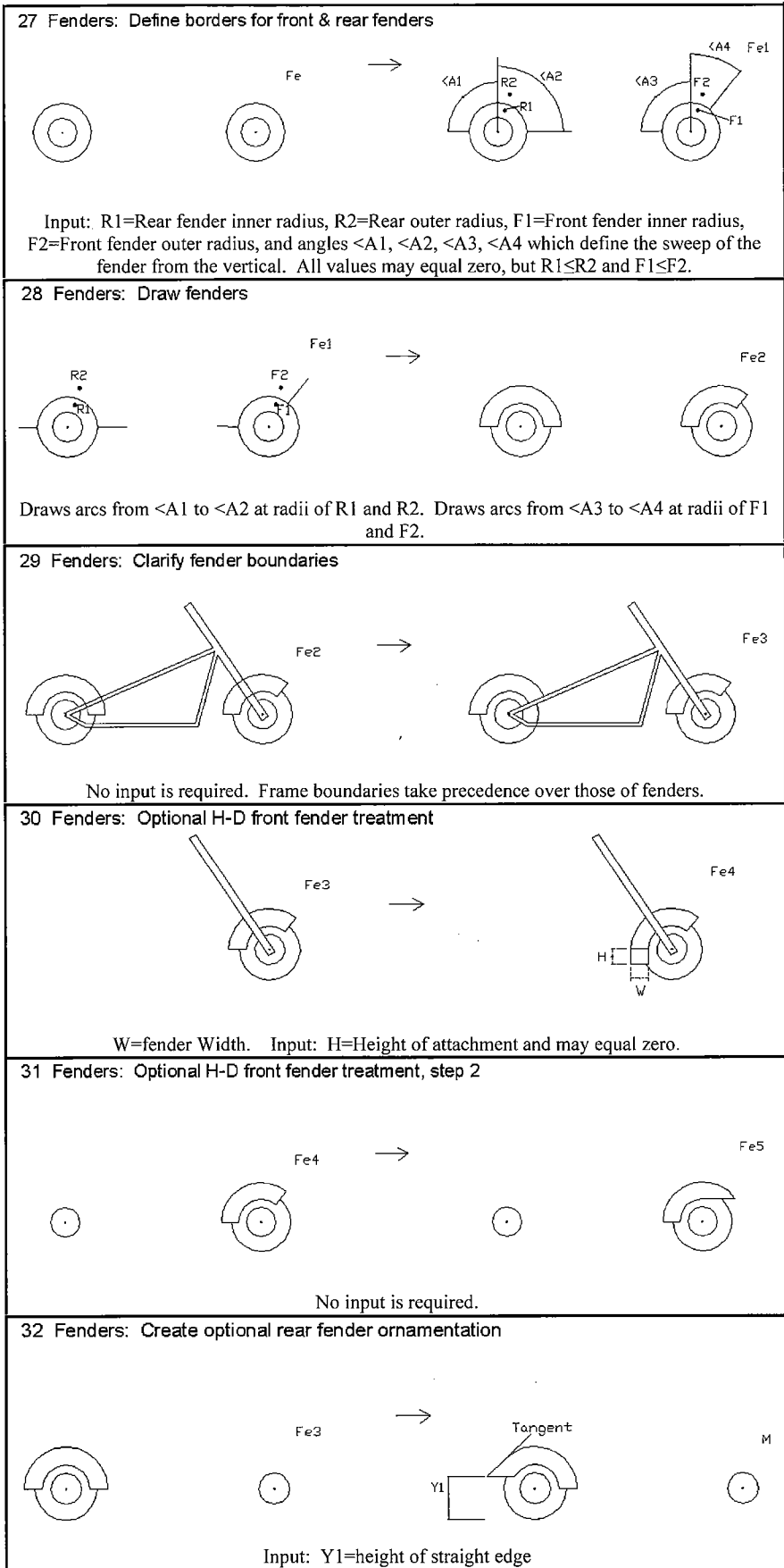

Fig. 10. Rules 27–35 create the fenders

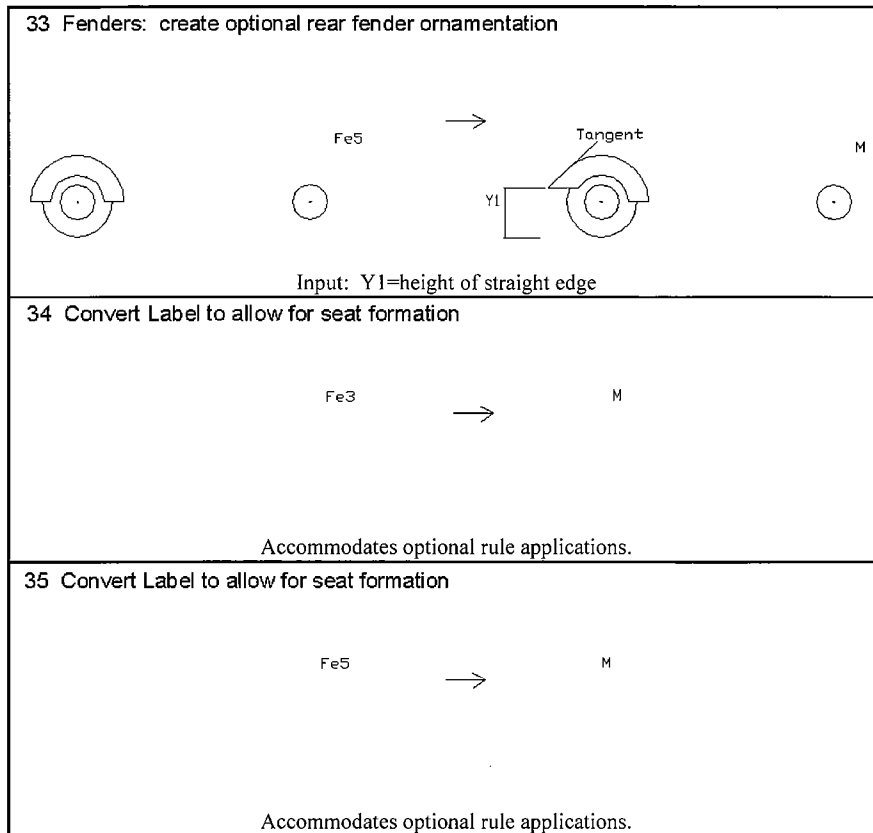

Fig. 10. (Continued)

- Rule 20: $P4_x > P5_x > P6_x > P1_x$; $P4_x > P3_x > P2_x > P1_x$;
- Rule 20: $P5_y > P6_y > P1_y$; $P4_y > P1_y$;
- Rule 20: X_c (from rule 17) $< P4_x < (Axf - 0.5 \times FT_{od})$;
- Rule 20: P3, P4, P5 joined by an arc;
- Rule 22: $F=0$;
- Rule 23: Applied to create instrument panel;
- Rule 23: Select points to define triangular profile.
- Lights: Domed headlight profile, taillight:
 - Rule 39: Applied for domed headlight, $h > 0$;
 - Rule 41: $W > 0, H > 0$.
- Seat: Cupped profile, extends from rear fender to tank:
 - Rule 36: $X10 = P1_x$ (of tank, from rule 20);
 - Rule 36: The surface formed by points 1, 3, 5, 7, 9 should include a concave surface.
- Fenders: Both front and rear fenders overlap tires:
 - Rule 27: $(0.5 \times RT_{id}) < R1 < (0.5 \times RT_{od}), R2 > (0.5 \times RT_{od})$;
 - Rule 27: $(0.5 \times FT_{id}) < F1 < (0.5 \times FT_{id}), F2 > (0.5 \times FT_{od})$.
- Wheels: Large wheels, front wheel larger or equal to rear:
 - Rule 3: $16'' \leq RT_{id} \leq FT_{id}$.
- Tires: Thick-walled (high-profile), rear tire thicker than front tire:
 - Rule 3: $(RT_{od} - RT_{id}) \geq (FT_{od} - FT_{id})$;
 - Rule 3: $RT_{od} \leq FT_{od}$.

These constraints limit rule application and parameter selection to those that strongly represent what we believe is the core brand. Harley-Davidson has produced several models, which, although they may be recognized as Harleys by a small group of longtime owners, stretch the

brand identity by diluting less critical characteristics of this motorcycle family by utilizing parameters outside the range of these constraints. Using all of the constraints described above will consistently model a motorcycle that we claim will be recognized as a Harley.

Constraining the grammar to create a classic Harley-Davidson

Following is an example demonstrating how the previously described constraints and rules can be applied to produce two-dimensional representations of Harley-Davidson motorcycles. Strict application of the rules as just described will produce a motorcycle drawing that fully satisfies the grammar's brand constraints in representing a classic Harley.

First, rules 1, 2, and 3 are applied to define the wheel-base and draw the axle hubs, wheels, and tires (Fig. 23). Rule 4 is then applied to create a two-part front fork (Fig. 24).

This example now applies rule 5 to initiate the construction of a cradle frame. Rule 5 creates the lower "base" segment of the frame. Ground clearance and the thickness of the base segment are assigned (Fig. 25).

At this point, the designer must determine which type of cradle frame to represent. Rule 6 could be applied to initiate the sequence of rules that creates a hard frame, or rule 9 could be applied for the soft-frame rule sequence. This example demonstrates application of rule 6, which leads to the creation of the hardtail-style frame by adding a connecting segment between the rear axle and the frame base. Rule 7 is applied to add the rib, or cradling segment,

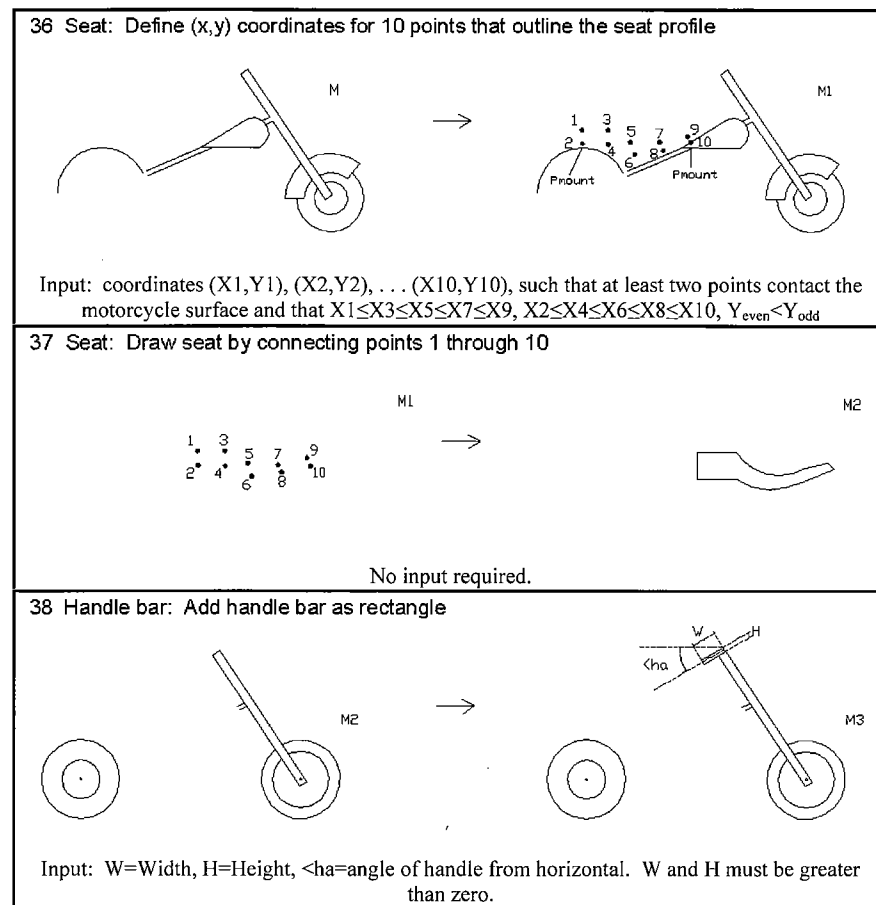

Fig. 11. Rules 36–38 develop the seat and handlebar

that connects the frame base to the front fork. The designer defines the angle that orients this segment from the frame's base segment. Rule 8 is applied to complete the frame by joining the rearward, connecting segment with the rib and front fork (Fig. 26).

To create the crankshaft housing and engine, rules 17 and 18 are applied; here parameter values are chosen to produce the classic 45-degree V-twin engine. Next, rules 20 through 22 are applied to create the classic teardrop shape. Now the designer may choose between adding an instrument panel (rule 23) or a fuel cap/speedometer gauge (rule 25). Here rule 23 is applied to plot the points that define the outline of an instrument panel. Rule 24 connects these points to complete the instrument panel (Fig. 27).

Rules 27 through 29 are applied to allow for definition of the fenders. Parameter values are chosen to create both front and rear fenders that overlap the tires. The grammar offers options for modifying the fenders; front fender treatments (rules 30 and 31), rear fender ornamentation (rules 32 or 33), or no further modifications (rules 34 or 35) may be applied. This example applies the sequence that will create a unique front fender style reflective of many classic Harley-Davidsons. First, rule 30 adds a rectangular segment to the front fender's trailing edge, then rule 31 tapers the leading edge. Next, rule 33 is applied to complete the fender design with a label conversion (Fig. 28).

Rule 36 is applied to plot the points that define the seat outline; here, parameter values are chosen to create a

cupped profile. Rule 37 is applied to connect these points with arcs and lines. Rule 38 is applied to create a rectangular handlebar (Fig. 29).

The grammar now calls for application of either rule 39 or 40 to create a headlight. Rule 39 is applied to create a semielliptical profile for the headlight, given three dimensions and a mounting point. Now rule 41 must be applied; this example adds a taillight using two dimensions and a mounting point. Rule 42 follows to clarify the boundaries of the lights from surrounding components (Fig. 30).

The final design decision is whether to apply an air filter. This example applies rule 43 to draw an elliptical air filter and finalize the design using two dimensions and a center point. Figure 31 displays the completed Harley-Davidson-based design.

Brand verification through customer-based survey

To verify that we have been able to capture the essence of the Harley brand, we used the grammar to generate ten motorcycles using varying levels of our Harley constraints. A web-based survey was then created to display these grammar-generated designs to Harley owners, collect information on each participant's motorcycle background, and record their perception of the generated models. The responses were used to evaluate the grammar's brand modeling ability against public perception of the Harley-Davidson brand. To reach a wide audience in a short amount of time, the survey was refined through

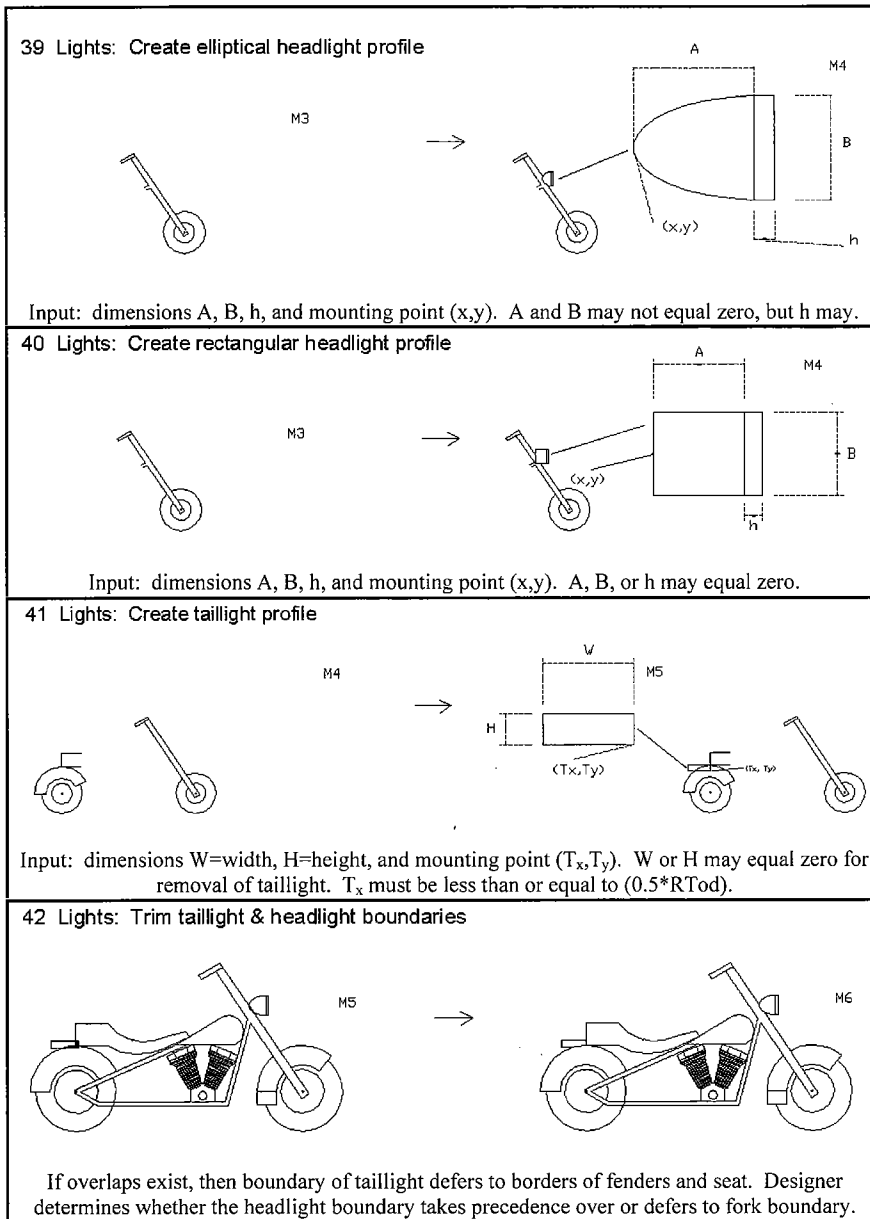

Fig. 12. Rules 39–42 add the headlight and taillight

two pilot studies and then published online¹. Over 150 responses were collected, including more than 100 from current Harley-Davidson owners that supplied the data for analysis.

The survey displays ten different grammar-generated motorcycles (shown in Fig. 32) and asks respondents whether each model is a Harley-Davidson or not. Models A and M were grammar-generated Harley-Davidsons, satisfying all grammar constraints for producing a Harley-Davidson model. Five models (C, E, F, G, and I) were not Harleys, but random motorcycle representations

that did not satisfy Harley constraints. The remaining three models (B, D, and S) demonstrated minor relaxation of various grammar constraints. The order that the motorcycles were presented was randomly set to models: A, B, C, D, E, F, M, G, I, S. The generated models demonstrate the following relaxations of the Harley constraints:

- *Model A*: none;
- *Model M*: none;
- *Model B*: slightly high rear end on softcradle frame that begins to lose the strong triangular shape, lacks instrument panel;
- *Model D*: flat seat that does not extend to the fuel tank, rotated fuel tank;
- *Model E*: rotated V-configuration, large gap between front fender and tire;
- *Model S*: rectangular headlight, flat seat, lacks instrument panel;

¹The Harley-Davidson groups contacted were: <http://aboutforums.com>, <http://www.halshd.com>, <http://www.totalhog.com>, <http://www.usedhawgs.com>, <http://members.tripod.com/~atlantahog/>, <http://www.bloomington.in.us/~hhills/>, <http://www.venturahog.com>, <http://members.iinet.au/~hogperth/>, <http://users.pipeline.com.au/fossil/>, <http://www.sandiegoharley.com/hogl.html>, <http://www.qsites.com/winstonchapter>.

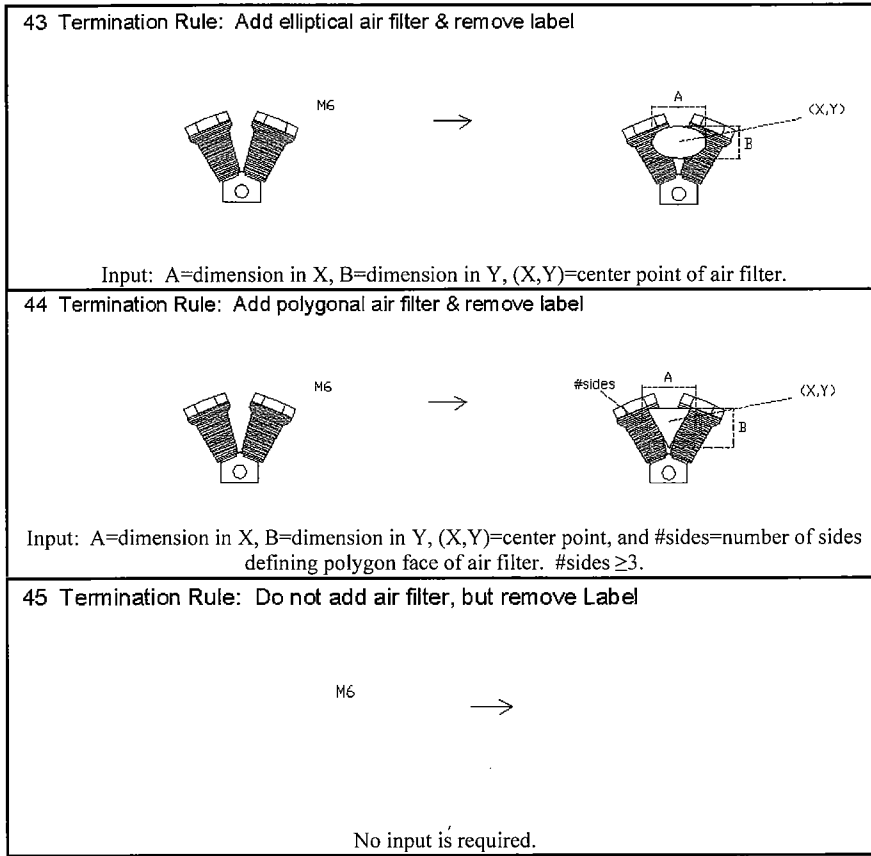

Fig. 13. Rules 43–45 allow for addition of an air filter and termination of the design

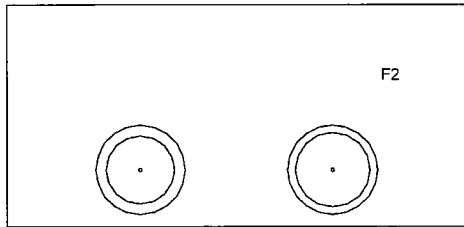

Fig. 14. After rule 3 has been applied

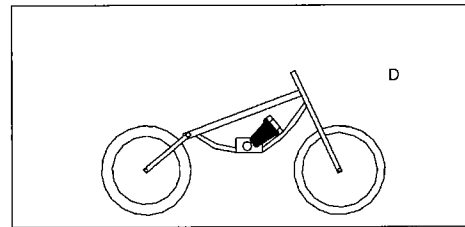

Fig. 17. After rule 19 has been applied, completing the engine

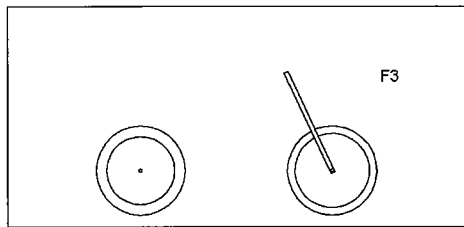

Fig. 15. After rule 4 has been applied, adding the front fork

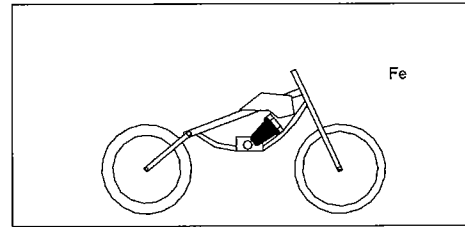

Fig. 18. After rule 26 has been applied

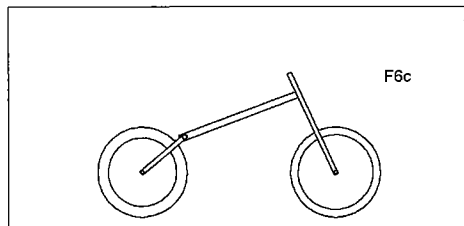

Fig. 16. After rule 16 has been applied, completing the stressed frame

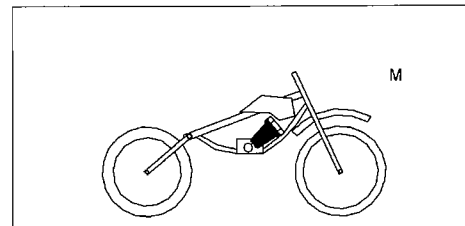

Fig. 19. After rule 34 has been applied, the fenders have been created

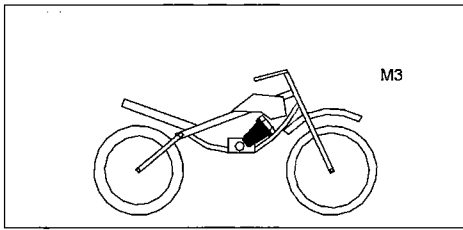

Fig. 20. After rule 38 has been applied, the seat and handlebar have been added

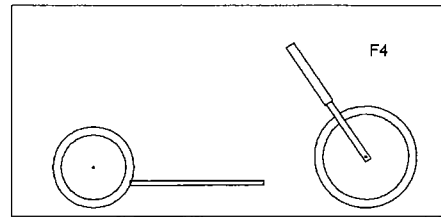

Fig. 25. After rule 5 has been applied, adding the base for the cradle frame

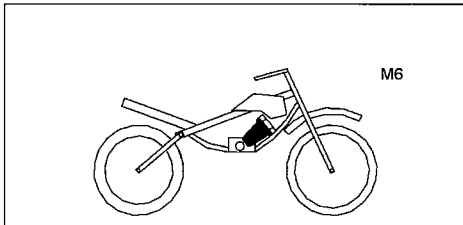

Fig. 21. After rule 42 has been applied

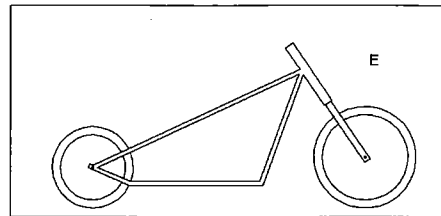

Fig. 26. After rule 8 has been applied, completing the hard cradle frame

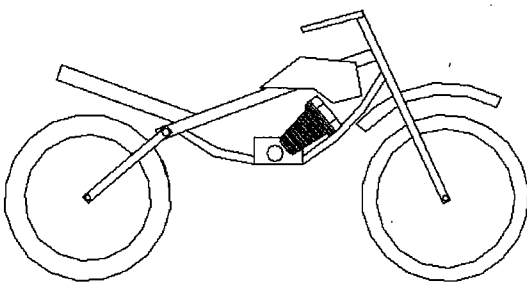

Fig. 22. A generated dirt bike

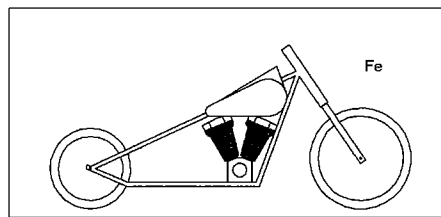

Fig. 27. After rule 24 has been applied, a V-twin engine, fuel tank, and instrument panel have been added

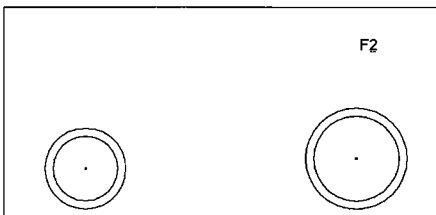

Fig. 23. After rule 3 has been applied

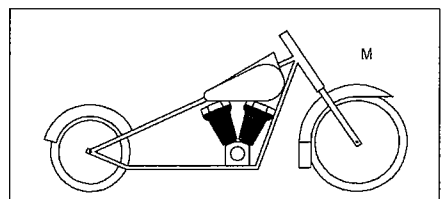

Fig. 28. After rule 33 has been applied, completing the fenders

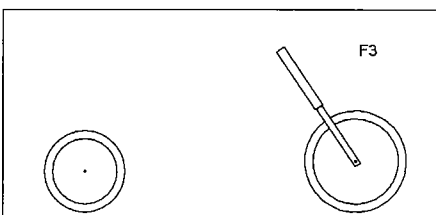

Fig. 24. After rule 4 has been applied, adding the front fork

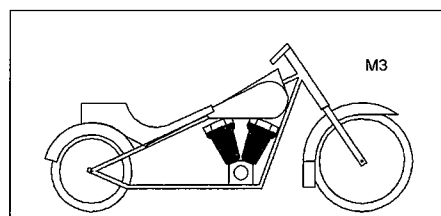

Fig. 29. After rule 38 has been applied, the seat and handlebar are defined

