

---

## A blend of different tastes: the language of coffeemakers

---

M Agarwal, J Cagan

Computational Design Laboratory, Department of Mechanical Engineering, Carnegie Mellon University, Pittsburgh, PA 15213, USA;

e-mail: magarwal+@andrew.cmu.edu, cagan@cmu.edu

Received 21 October 1996; in revised form 18 March 1997

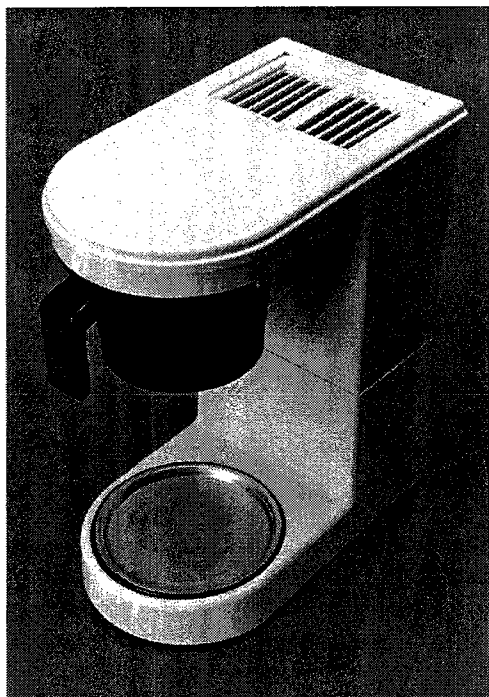
---

**Abstract.** Shape grammars, utilizing function labels, are shown to be applicable to product design. A grammar that describes a language of coffeemakers is presented and shown to generate a large class of coffeemakers currently on the market, as well as new designs that could be introduced to consumers.

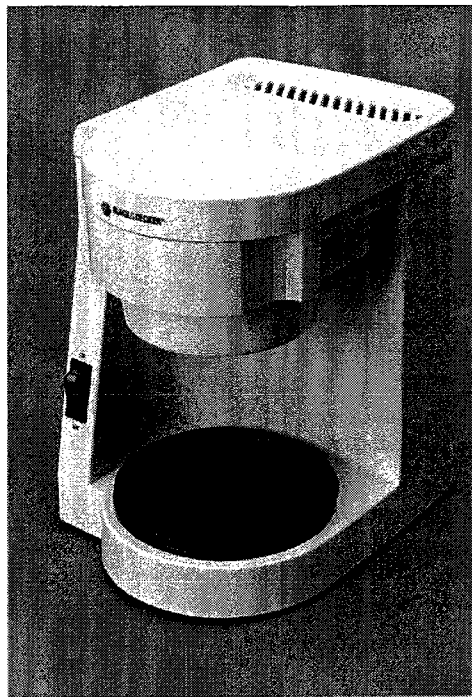
### 1 Introduction

Established consumer products take on different shapes and features to fill various market niches and distinguish themselves among their competition. However, many of these product classes have essentially the same functional breakdown. One example is that of coffeemakers. Although there exist many different brands of coffeemakers, and much variety even within a given brand, most coffeemakers function based on a single procedure: water is first poured into and stored within a container; it then flows through a heating element, turns to steam, and rises through a tube where, at the top, it expands, condenses, and flows into a filter. The hot water mixes with the coffee grounds within the filter (which also controls the amount of time the mixing occurs based on its shape). The coffee is then released into a coffee pot below where it is kept warm on a burner that is heated either by the same heater that turned the water to steam or, in more expensive models, by a separate heating element. Most major brands of coffeemakers (Krupps, Black & Decker, Proctor Silex, Braun, etc) follow this basic principle even if augmented by digital control features, exotic materials and colors, and avant garde shapes.

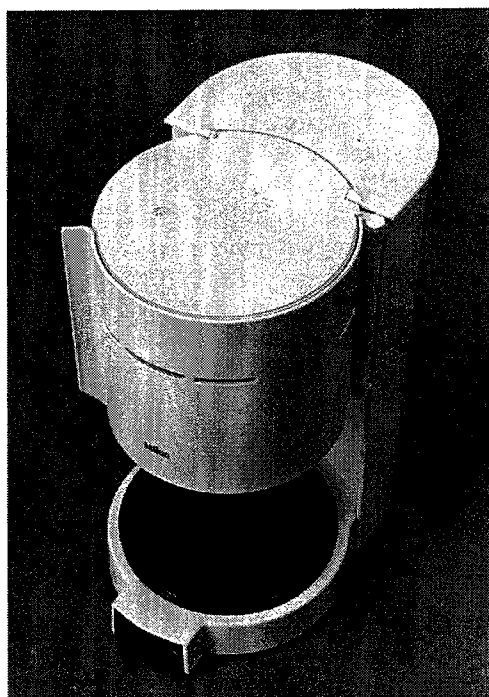
With coffeemakers, this basic functionality drives the requirements of the form of the product: the water heater must be below the water storage unit, the filter unit must be above the heater (but not so high that the water condenses prematurely), the coffee pot must be below the filter unit, and the burner must be below the coffee pot. Even with these requirements on function and form topology, the market has demanded and supported a wide variety of coffeemakers, from the simple to the sleek. In figure 1 (see over), a variety of common brands are shown: Proctor Silex; Black and Decker; Braun; and Krups. Note that, although some appear more contemporary, smooth, and costly, each of them have the basic forms discussed above: water is poured into the water storage unit found in the back, in the front is a coffee pot that rests on a burner, and above this pot is the filter unit that is attached to the top of the water storage unit. Each of these models are single-burner units which means that a single heater resides in the burner, and tubing leads from the bottom of the water container to the heater and from the heater to the filter unit. Beyond these similarities these models are quite unique, based on the shape of the unit as a whole and in particular the shape of the water storage unit. The filters too take different forms with the less expensive models having filters that slide out and the more expensive models having filters that rotate out and also a lever that prevents coffee from flowing if the pot is not seated properly beneath.



(a)



(b)



(c)



(d)

**Figure 1.** Coffeemakers: (a) Proctor Silex, (b) Black & Decker, (c) Braun, (d) Krups.

---

The different shapes of the coffeemakers are driven by corporate image and market niches. The chief designer at Braun, Dieter Rams, in particular has a philosophy of design that includes the principles that good design is innovative, enhances the usefulness of a product, displays the logical structure of a product, and is enduring, honest, minimal, and consistent right down to details (DMI, 1990). These principles are consistent with the consumer impression of Braun and, in the authors' opinion, the coffeemaker illustrated in figure 1(c); the Braun gives the impression of being of high quality and reliability, simple yet contemporary form, lasting, and expensive. The other coffeemakers in figure 1 are most likely consistent with consumers' impressions of the other corporate identities<sup>(1)</sup>: the Proctor Silex is simple, inexpensive, but works well; the Black & Decker is hardy, reliable, and of good value; the Krups, like the Braun, is of high quality and cost, of contemporary form, and lasting.

The various coffeemakers fill different market niches: the Proctor Silex, and Black & Decker models shown here are inexpensive and disposable whereas the Krups and Braun are more costly and will satisfy the customers' needs for an extended period of time. As one examines the variety of coffeemakers on the market, one recognizes many different features from which consumers may choose.

Companies must react to the various markets while maintaining their corporate identity. One could even consider the trend towards one-of-a-kind design and rapid time-to-market as the limit of the multitude of designs that consumers may desire.

The coffeemaker product is not unique. Many classes of consumer products such as blenders, toasters, ovens, flashlights, telephones, and more, vary from their competition by shape and features but are based on the same functional principles and the same breakdown of form topology as their competitors.

In this paper we propose that shape grammars, whose application has been mostly within the field of architecture, are ideal for modeling such classes of consumer products. Within shape grammars, products can be partitioned into different topological regions which are often built around a given shape [for example, in the grammar of the Frank Lloyd Wright prairie houses (Koning and Eizenberg, 1981) the houses are built off the fireplace]. Labels can be used to connect the different regions together and make functional decisions about product features. We illustrate these ideas by introducing a parametric shape grammar for the design of coffeemakers. An initial shape representing a coffee pot is used to partition the form into three regions: the base, the water storage container, and the filter unit. Each of these regions is designed individually and then blended together into a final form. The choice of one or two heating elements, sliding or rotating filter, flat or conical filter, fixed flow or variable flow, and continuous flow or stop-lever-design features are determined via function labels. The grammar is used to generate a variety of coffeemakers including those designs currently on the market, as illustrated in figure 1, and new design concepts.

We propose that shape grammars for product design such as the one presented here can be used to support the conceptual design of these products. They allow the designer to explore different shape options through modification of a single rule or parametric value. They allow a company to maintain certain rule or parameter value choices to model their corporate image, to learn about their corporate image by identifying what rule or parameter choices they tend to use, and to learn about their competitors' image. They allow for the rapid generation of design concepts to improve the time-to-market cycle and increase one-of-a-kind design capabilities. However, we recognize too the limitation of design conceptualization potentially imposed by such a grammar; the grammar is best used for the generation of standard products within the routine form

<sup>(1)</sup> All subjective comments about the coffeemakers are solely the opinions of the authors unless otherwise noted.

and function framework already discussed. Radical changes to the design will most likely occur outside of the given grammar, although creative forms are still achievable from the grammar<sup>(2)</sup>. An important feature of shape grammars is that they can be easily adapted by adding and removing shape rules and thus new design characteristics can be incorporated into the language.

In the next section, related literature will be discussed. Next, the coffeemaker grammar will be presented and then a detailed example shown. Finally a variety of coffeemakers generated by the grammar will be presented followed by the conclusions.

## 2 Shape grammars

Shape grammars (Stiny, 1980) have been used successfully to generate a variety of architectural designs including villas in the style of Palladio (Stiny and Mitchell, 1978), Mughul gardens (Stiny and Mitchell, 1980), prairie houses in the style of Frank Lloyd Wright (Koning and Eizenberg, 1981), Greek meander patterns (Knight, 1986), suburban Queen Anne houses (Flemming, 1987), and windows in the style of Frank Lloyd Wright (Rollo, 1995). A shape grammar derives designs in the language which it specifies by successive application of shape transformation rules to some evolving shape, starting with an initial shape ( $I$ ). In particular, given a finite set of shapes ( $S$ ) and a finite set of labels ( $L$ ), a finite set of shape rules ( $R$ ) of the form  $\alpha \rightarrow \beta$  transform a labeled shape  $\alpha$  in  $(S, L)^+$  into a labeled shape  $\beta$  in  $(S, L)^0$ , where  $(S, L)^+$  is the set of all labeled shapes made up of shapes in the set of  $S$  and symbols in the set  $L$ , and  $(S, L)^0$  is the set that contains in addition to all of the labeled shapes in the set  $(S, L)^+$  the empty labeled shape  $\langle s_\phi, \phi \rangle$ . Shapes themselves can be transformed with Boolean operations. Parametric shape grammars are an extension of shape grammars in which shape rules are defined by filling in the open terms in a general schema. An assignment,  $g$ , which gives specific values to all the variables in  $\alpha$  and  $\beta$  determines a shape rule,  $g(\alpha) \rightarrow g(\beta)$ , which can then be applied on a labeled shape in the usual way to generate a new labeled shape. This work takes advantage of labels and parametric shapes in the derivation of a concise shape grammar for coffeemakers.

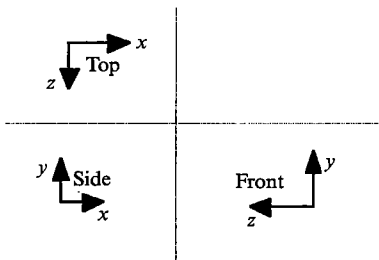
There has been limited application of shape grammars to engineering design. Fitzhorn (1990) and Longenecker and Fitzhorn (1991) present shape grammars specifying the languages of constructive solid geometry and boundary representations (that is, realizable solids). Brown et al (1993) present a manufacturing-oriented shape grammar which specifies the language of all axisymmetric objects manufacturable on a given lathe. Reddy and Cagan (1995a; 1995b) and Shea et al (1997) present a parametric shape grammar for the design of truss structures that uses the shape annealing technique of Cagan and Mitchell (1993) to generate optimal truss structures. This work is the first in which shape grammars are applied to a class of individual products.

## 3 A shape grammar for coffeemakers

In this section we present a shape grammar for the design of coffeemakers as an example of the applicability of shape grammars to product design. The function and form topology breakdown has already been discussed. Owing to the lack of functional coupling, the design procedure can be decomposed into function design and form design. The function drives the form in the product and in the application of the grammar rules; function labels are designed to maintain the proper function-to-form sequence. The grammar is a parametric labeled two-dimensional (2-D) shape grammar

<sup>(2)</sup> Brown and Cagan (1996) formally define the creative solution capabilities with grammars as *bounded creativity*: if an agent behaves in a manner that is within limits specified by the grammar but beyond its standard practice for the current goal, then the solution approach is considered creative.

that through three views of the product—top, side, front—creates a three-dimensional (3-D) shape. Figure 2 shows the notation for the three views, separated by hairlines, as used within the shape grammar. In general, any rule in the grammar manipulates these three views. By default, if only one view is illustrated then only that view is manipulated; unless otherwise noted, if only one view is shown then that view is the side view. The grammar is shown in figures 3–7. The coffeemaker is considered to be made up of three main parts: the filter unit, the water storage unit, and the base unit. These three units are arranged around the space for the coffee pot which acts as the initial shape for the grammar.



**Figure 2.** Notation for positioning of views in shape rules; single image is a side view unless specified otherwise.

The first set of rules, called initial shape rules as shown in figure 3 (see over), distinguishes between two main classes of coffeemakers, those with one heating element and those with two, and divide the basic form into the three regions. Rules 1 and 2 take as an initial shape a rectangular side cross section of the boundary of the space in which the coffee pot fits and distinguish between the two classes; a square label is associated with the initial shape to indicate a single-heater design, and a triangular label is used for double-heater designs. In addition labeled points (indicated by solid dots and the associated label) p and z are added to define the right-most bounds on the design. These two points are constrained by

$$x_z = x_p.$$

Arbitrary points along the top, left-hand side, and bottom of the initial shape are given the labels F, W, and B, respectively, indicating the filter, water storage unit, and base regions.

Next the basic cross-sectional shapes of the filter and base regions are designed by means of parametric rules 3–5 for the top, bottom rear, and bottom front, respectively. The position of the labeled points in rule 3 for the top of the unit are restricted based on the following constraints:

$$|x_{t''} - x_{a'}| = |x_{t'} - x_{b'}|,$$

$$|x_{s''} - x_{a'}| = |x_{s'} - x_{b'}|,$$

$$|x_{p'} - x_{a'}| = |x_{t'} - x_{b'}|,$$

$$y_{t''} = y_{a'} = y_{t'} = y_{b'},$$

$$y_{s''} = y_{s'} > y_{t'},$$

$$y_{p'} = y_{t'} > y_{s'}.$$

The first three constraints ensure a symmetric filter unit formed by line  $r' s' t' b' a' t'' s'' p' r'$ . The next three constraints ensure that there are no reentrant corners in

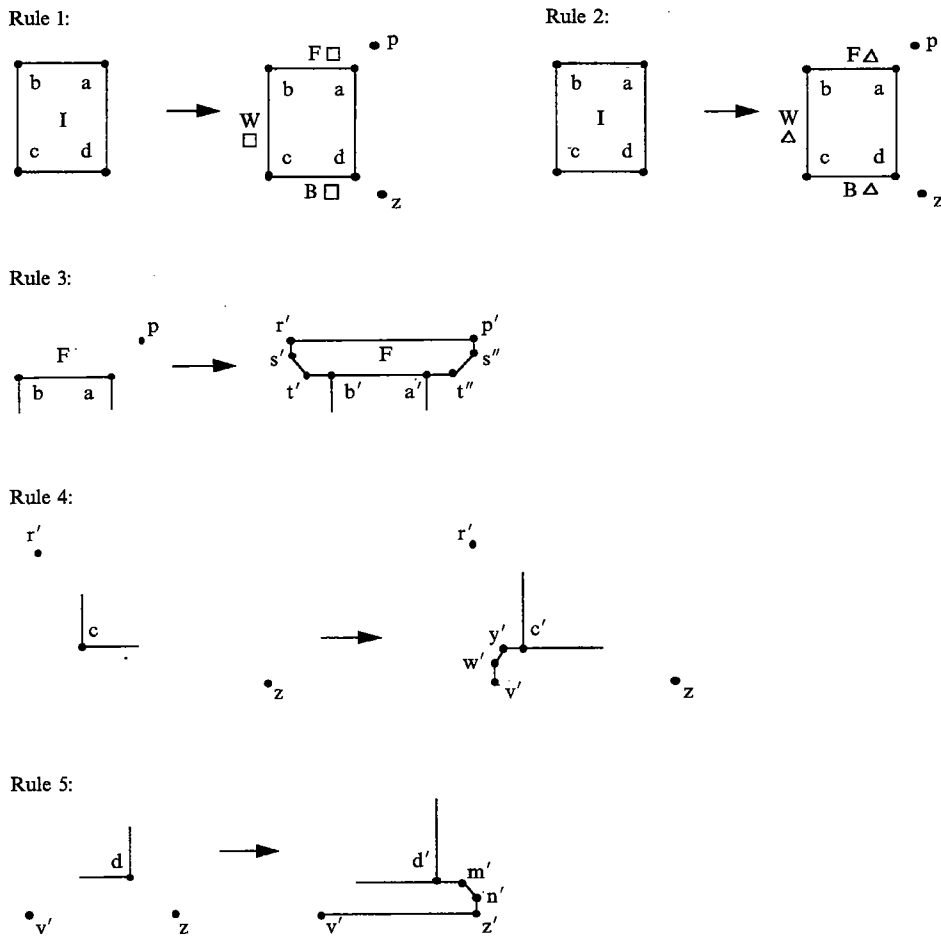


Figure 3. Initial shape rules.

the filter. Note that on the right-hand side, labeled point a goes to labeled point a', and b goes to b'.

Rule 4 generates the shape of the bottom rear of the unit restricted by the following constraints:

$$x_{c'} \geq x_{y'} \geq x_{w'} \geq x_{v'}$$

$$y_{c'} \geq y_{y'} \geq y_{w'} \geq y_{v'}$$

$$y_{v'} = y_z$$

$$y_{c'} = y_{y'}$$

$$x_{w'} = x_{v'}$$

$$y_{y'} \neq y_{w'}$$

The first two constraints ensure no reentrant corners. The third constraint ensures a horizontal base. The tubing into the base, if required, enters between points labeled w' and y'; the last three constraints ensure that line w' y' lies on the common boundary between the water storage unit and the base.

---

Rule 5 specifies the bottom front of the unit restricted by the following constraints:

$$x_{z'} \geq x_{a'} \geq x_{m'} \geq x_{d'}$$

$$y_{d'} \geq y_{m'} > y_{n'} \geq y_{z'}$$

$$y_{d'} = y_{m'}$$

$$x_{z'} \geq x_{a'}$$

The first two constraints again ensure no reentrant corners and the last two place restrictions on the form of the unit for desired design characteristics.

Next, each of the three units are designed separately. In each unit, functional requirements are considered initially, driving the form decisions later. First, the filter unit is designed. Shape rules 6–15 are used to address its functional requirements through the manipulation of labels (figure 4, see over). All labels specified in these shape rules are associated with the point previously labeled F. Labels 1, 2, 3, 4, and 5 are used to generate the functional specifications of the filter unit. Label F is changed to F' to ensure that the function design rules cannot be reapplied. The presence of a label implies that the functionality associated with that label has not yet been addressed. Label 1 is used to decide between a rotating and a sliding filter: FM<sub>1</sub> refers to a sliding filter, and FM<sub>2</sub> refers to a rotating filter. After the functionality associated with label 1 is designed, the label is changed to 1' and it plays no other part in the functional design of the filter unit. This process is then repeated for labels 2, 3, 4, and 5. FT<sub>1</sub> refers to a conical filter, and FT<sub>2</sub> refers to a flat filter. FI refers to the inlet tube which is present in all coffeemakers. FF<sub>1</sub> refers to a fixed-flow coffeemaker, and FF<sub>2</sub> refers to a variable-flow coffeemaker. FS<sub>1</sub> refers to a mechanism to stop the coffee from dripping when the pot is not in place, and FS<sub>2</sub> is used when the mechanism does not exist. After all five labels 1–5 have been removed and the new labels 1'–5' created, the functional design of the filter unit is complete. The grammar is readily extendible for added functionality through the addition of labels and resulting shape rules.

Once the functionality of the filter unit is specified, its form is designed by use of rules 16–26. The form design is governed by the labels generated during the functional design stage. First, rule 16 removes unnecessary labels. Rule 17 then partitions the filter unit into a top portion and a movable bottom filter and generates a top view. Rules 18 and 19 produce either sliding or rotating filters (the rotating hinge is indicated by the vertical dotted line). In the top view of these rules the center point is specified through a  $\mathcal{C}$  notation and the extreme left-most points on the top and bottom of the filter unit are specified through points labeled C<sub>1</sub> and C<sub>2</sub> (labels C<sub>1</sub> and C<sub>2</sub> correspond to points that lie on the planes containing r'' and s', respectively). These extreme points are used to define horizontal transition planes that will be used later to permit a transition in the shape of the water storage unit in the vertical direction. Rules 20 and 21 generate either conical or flat filters. Rule 22 adds water tubing to the filter unit. Rule 24 adds in the variable-flow mechanism (whereas rule 23 indicates that no such mechanism is present). Rule 25 adds in the optional water stop (rule 26 states that no water stop exists). Rules 25 and 26 also change the label s' to s''' to allow the water storage unit to be designed later. Again, the labels are associated with the unit in such a way that the form design can be carried out only in a particular order so that all functional requirements may be met [for example, the water tube (rule 22) cannot be applied until the top view is generated (rule 17)].

After the filter unit is completed, the base unit is designed by use of rules 27–37 (figure 5, see page 214). First, unnecessary labels are removed (rule 27) and function labels 6 and 7 added. Label B is changed to B' to prevent the reapplication of the

- |  |   |  |   |
|--|---|--|---|
| Rule 6: $F \rightarrow$                                    | $\begin{matrix} 1 & 2 & 3 & 4 & 5 \\ & & & & F' \end{matrix}$ | Rule 7: $F' \rightarrow$                                   | $\begin{matrix} 1' \\ F' \end{matrix} FM_1$ |
| Rule 8: $\begin{matrix} 1 \\ F' \end{matrix} \rightarrow$  | $\begin{matrix} 1' \\ F' \end{matrix} FM_2$                   | Rule 9: $\begin{matrix} 2 \\ F' \end{matrix} \rightarrow$  | $\begin{matrix} 2' \\ F' \end{matrix} FT_1$ |
| Rule 10: $\begin{matrix} 2 \\ F' \end{matrix} \rightarrow$ | $\begin{matrix} 2' \\ F' \end{matrix} FT_2$                   | Rule 11: $\begin{matrix} 3 \\ F' \end{matrix} \rightarrow$ | $\begin{matrix} 3' \\ F' \end{matrix} FI$   |
| Rule 12: $\begin{matrix} 4 \\ F' \end{matrix} \rightarrow$ | $\begin{matrix} 4' \\ F' \end{matrix} FF_1$                   | Rule 13: $\begin{matrix} 4 \\ F' \end{matrix} \rightarrow$ | $\begin{matrix} 4' \\ F' \end{matrix} FF_2$ |
| Rule 14: $\begin{matrix} 5 \\ F' \end{matrix} \rightarrow$ | $\begin{matrix} 5' \\ F' \end{matrix} FS_1$                   | Rule 15: $\begin{matrix} 5 \\ F' \end{matrix} \rightarrow$ | $\begin{matrix} 5' \\ F' \end{matrix} FS_2$ |

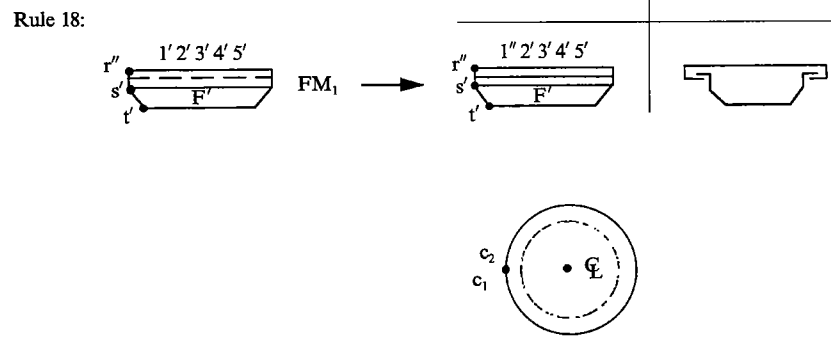
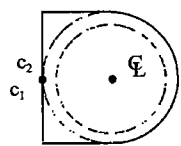
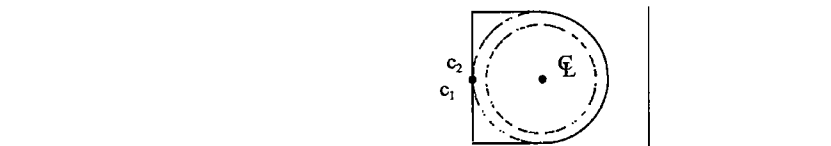
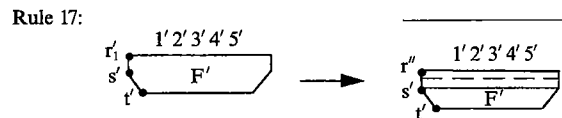
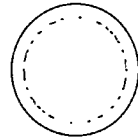
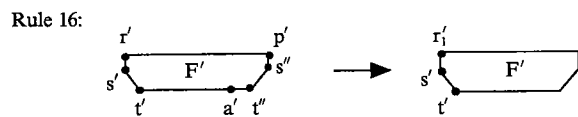


Figure 4. Filter rules.



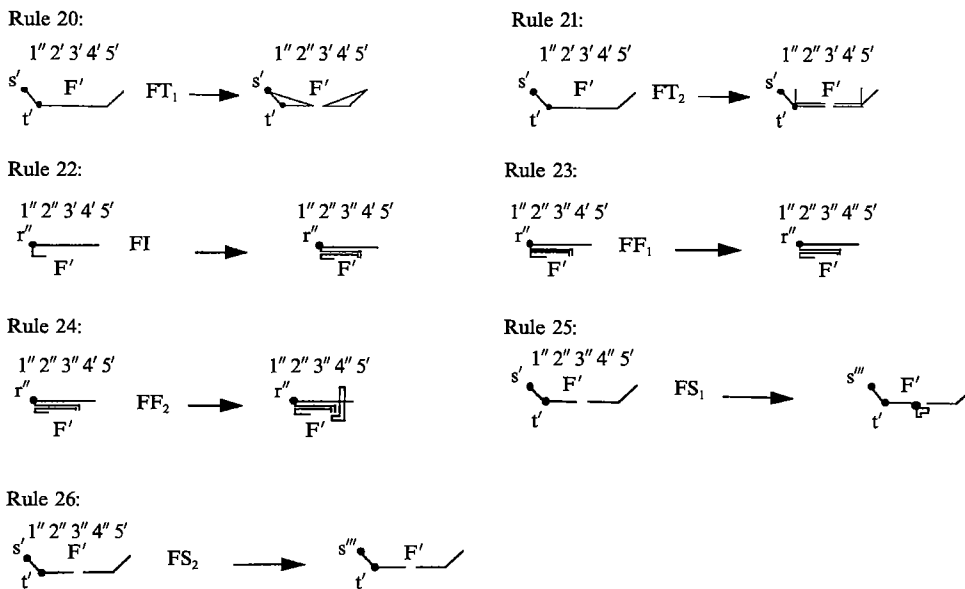


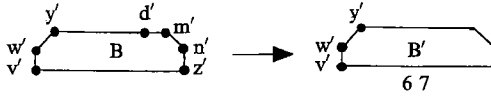
Figure 4 (continued).

function design rules. The basic ideas used in designing the base unit are similar to those used in generating the filter unit. But here the designer chooses either rule 28 which designs a polygonal section with an arbitrary number of vertices (where vertices  $v_1 - v_n$ , which are also labeled points, must lie on parallel lines to vertices  $v'_1 - v'_n$ ) or rule 29 which designs an elliptical section. These rules give the grammar a generality not usually seen in current products; more restrictive (or general) rules can be substituted if desired. Note that in these rules the  $x$  coordinate of the extreme points of the base are prespecified by rule numbers 1, 2, and 4. Again the center point is specified along with points labeled  $C_3$  and  $C_4$  (for the polygonal base shape, at the location of labeled points  $C_3$  and  $C_4$ , there also exist additional labeled shapes  $v_1$  and  $v'_1$ , respectively) to indicate the extreme left-most points of the top and bottom of the base (and to create two more transition planes to be used later). A designer-specified burner is also placed on the part of the top of the base unit on which the pot rests. The base heater is now added and, depending upon whether the unit has one or two heating elements, the water-carrying tubes are included between points labeled  $w'$  and  $y'$  (rules 30 and 31); label  $w'$  is also changed to  $w''$  to allow the water storage unit to be designed later.

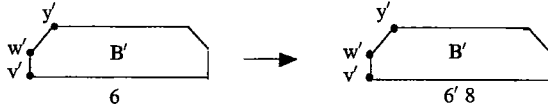
Next, to complete the base unit the top of the base is joined with the bottom. Note that rule 28, which chose a polygonal as opposed to an elliptical shape for the base, added label 8. If label 8 is present, rules 32–35, and then rules 36 and 37, are applied to connect the polygonal top to the polygonal bottom, possibly through an intermediary line if such a break is specified. The points labeled  $v_k$  and  $v'_k$  refer to labeled vertices  $v_1, \dots, v_n$  and  $v'_1, \dots, v'_n$  generated in rule 28. Elliptical shapes are assumed to have a smooth blend and thus require no additional rules.

Next, the grammar focuses on the water storage unit. The right-hand part of the center side cross section of the water storage unit was formed by the preceding rules by merging the initial shape with the boundary between the water storage unit and the filter and base units. The steps in generating the water storage unit are similar to those used in the generation of the filter and base units; however, unlike those units, the water storage unit is first only partially designed by using rules 38–42 (figure 6). The unit is completed in the next stage where it is used to blend the various subunits into a

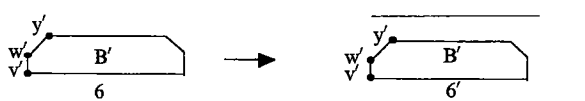
Rule 27:



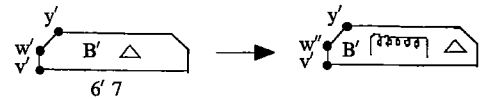
Rule 28:



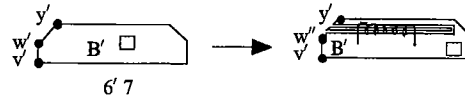
Rule 29:



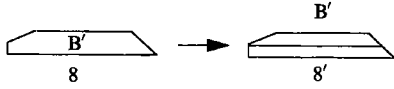
Rule 30:



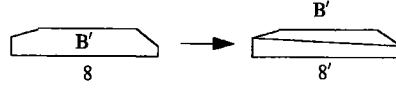
Rule 31:



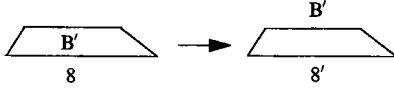
Rule 32:



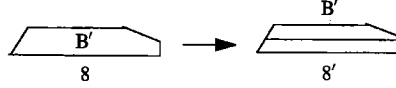
Rule 33:



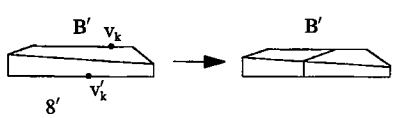
Rule 34:



Rule 35:



Rule 36:



Rule 37:

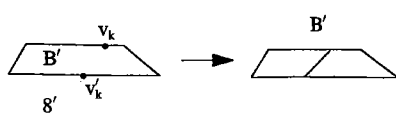


Figure 5. Base design rules.

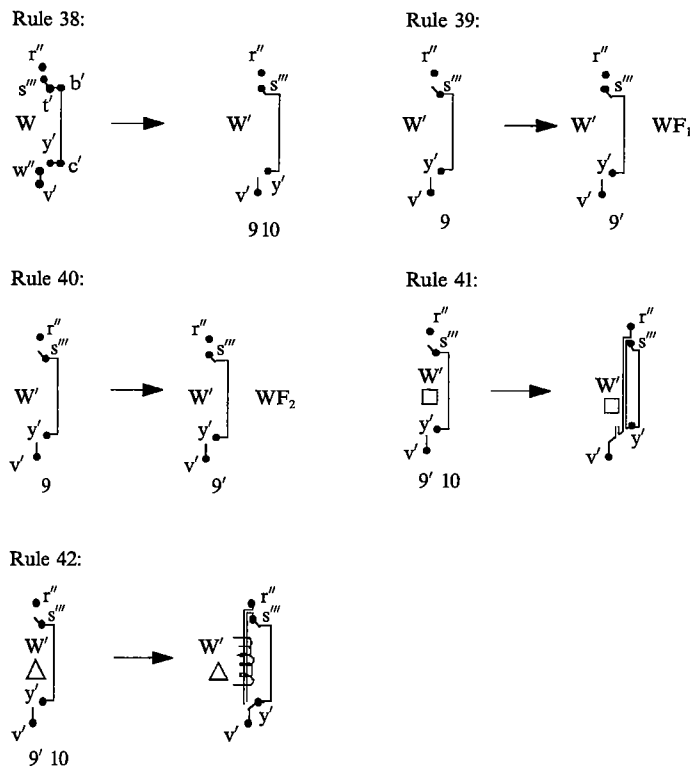


Figure 6. Design rules for the cross section of the water storage unit.

single, finished, coffeemaker. Label  $WF_1$  indicates a hinged top for the water storage unit, whereas  $WF_2$  models a grating at the top for filling water. Rule 41 places the water tubing in the unit for a single heating unit; rule 42 places the heater and tubing for a double-heater design.

The design is completed with rules 43–100, resulting in a water storage unit that conforms to the filter and base units (figure 7, see over). With the exception of rules 43–46, all the rules in figure 7 show only the top view. Points  $C_1, C_2, C_3,$  and  $C_4$  lie on four different horizontal planes also containing  $r'', s''', y',$  and  $v'$ , respectively. To allow for varying cross sections within the water storage unit the grammar requires the top view cross sections of that unit on these four planes to be generated separately. The bounds along the  $x$  direction of the shape within the planes are specified by rule 43. On each plane two additional points labeled, from top plane to bottom plane in the side view,  $\alpha_1$  and  $\alpha_2, \beta_1$  and  $\beta_2, \gamma_1,$  and  $\gamma_2, \delta_1$  and  $\delta_2$  (and in the top view the analogous primed labeled points) indicate critical points defining a range in which the left-most point of the section generated by rules 47–54 must lie. Note that, because the labels are associated with 2-D shapes and not with the corresponding solids, the same labels cannot be used in different views; however, *analogous* labels can be used in the different views. The right-most point of the same section must lie within the range specified by points  $C_1, \dots, C_4$  and the center line  $\mathcal{C}_L$ . These restrictions are imposed to ensure that the water tubing and water lid or grating lie within the specified volume of the water storage unit<sup>(3)</sup> and that the filter and base units merge with the water storage unit. Rule 55 through 70 then add additional connected shapes to each plane. These shapes

<sup>(3)</sup> Enough space must be allocated between  $\alpha_1$  and  $r'', \beta_1$  and  $s''', \gamma_1$  and  $y',$  and  $\delta_1$  and  $v'$ , to allow for the placement of the water tubing.

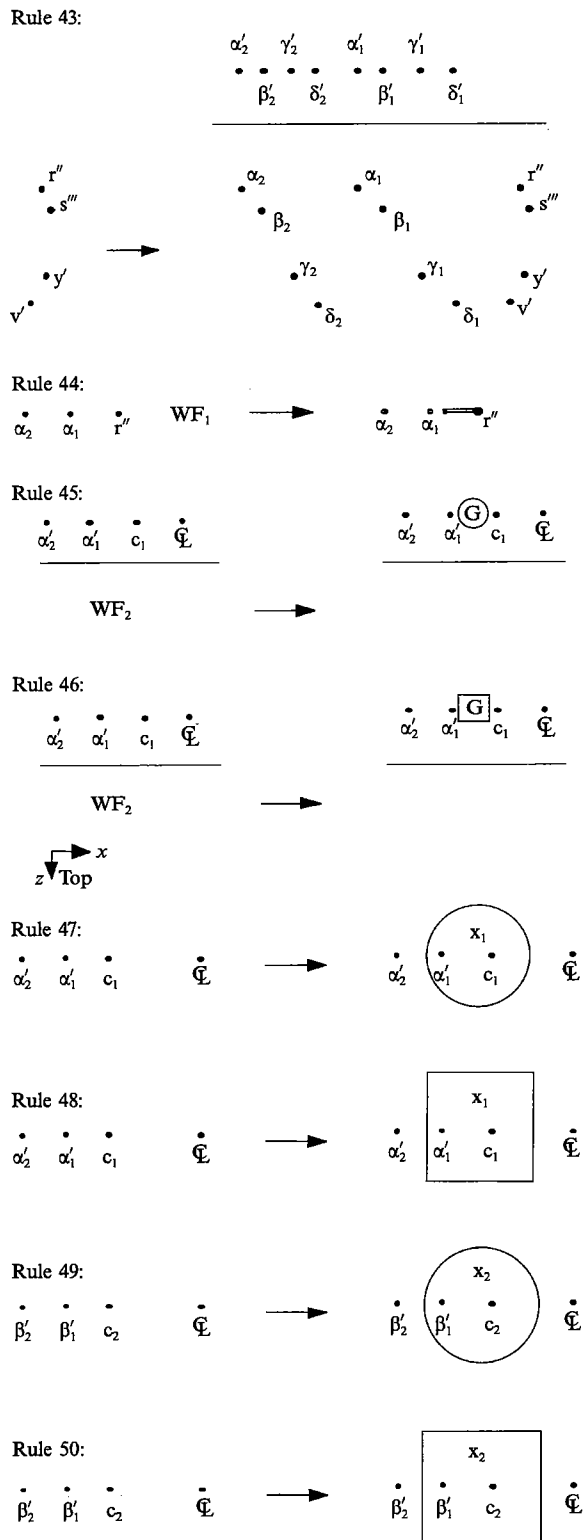
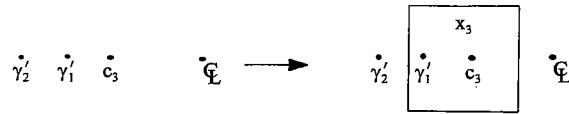


Figure 7. Completion rules.

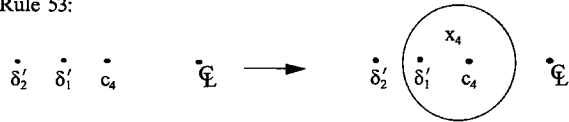
Rule 51:



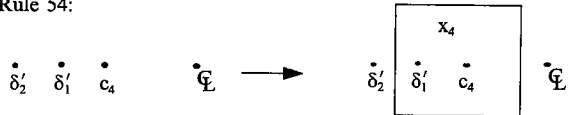
Rule 52:



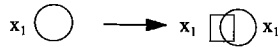
Rule 53:



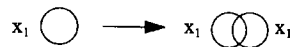
Rule 54:



Rule 55:



Rule 56:



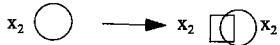
Rule 57:



Rule 58:



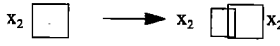
Rule 59:



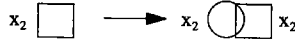
Rule 60:



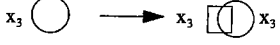
Rule 61:



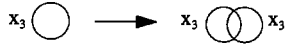
Rule 62:



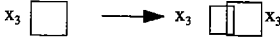
Rule 63:



Rule 64:



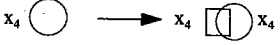
Rule 65:



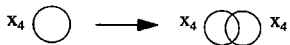
Rule 66:



Rule 67:



Rule 68:



Rule 69:

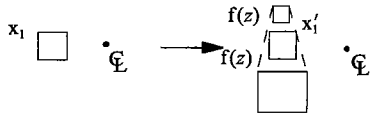


Rule 70:

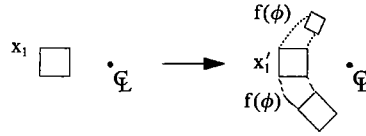


Figure 7 (continued)

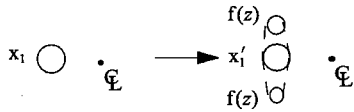
Rule 71:



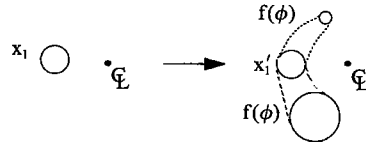
Rule 72:



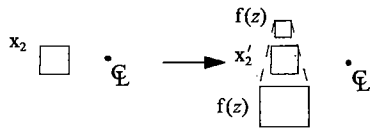
Rule 73:



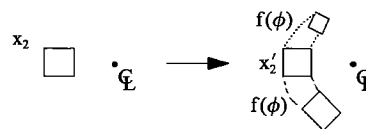
Rule 74:



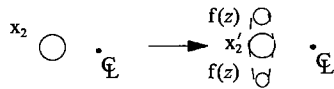
Rule 75:



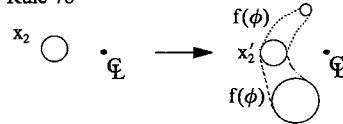
Rule 76:



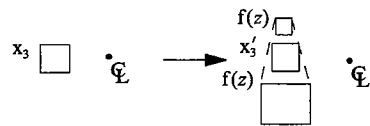
Rule 77:



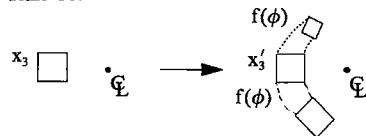
Rule 78:



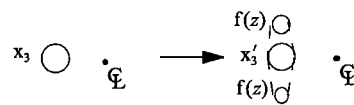
Rule 79:



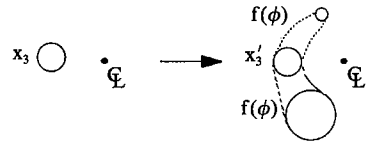
Rule 80:



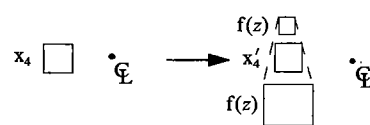
Rule 81:



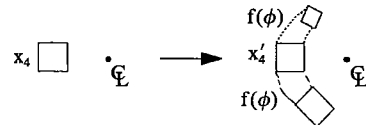
Rule 82:



Rule 83:



Rule 84:



Rule 85:



Rule 86:

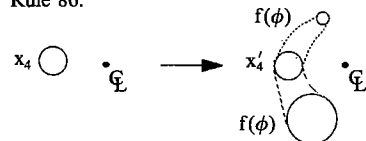
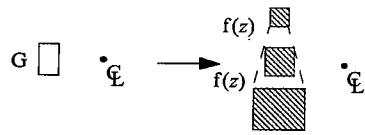
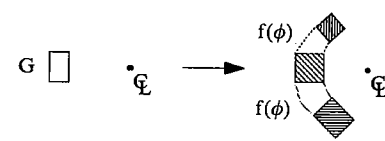


Figure 7 (continued)

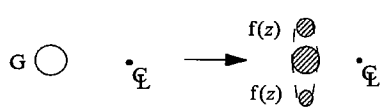
Rule 87:



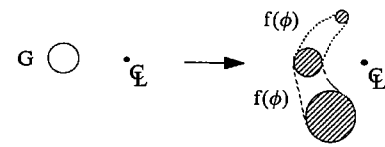
Rule 88:



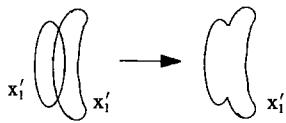
Rule 89:



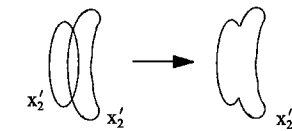
Rule 90:



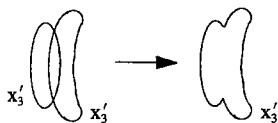
Rule 91:



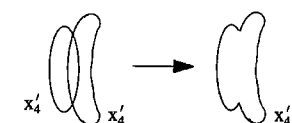
Rule 92:



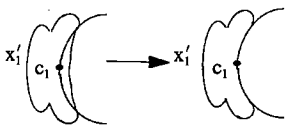
Rule 93:



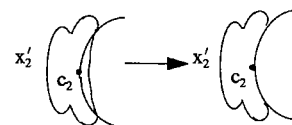
Rule 94:



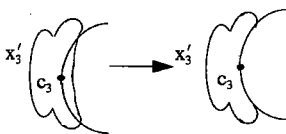
Rule 95:



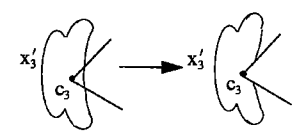
Rule 96:



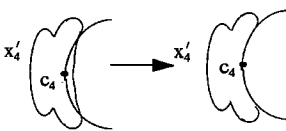
Rule 97:



Rule 98:



Rule 99:



Rule 100:

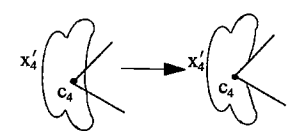


Figure 7 (continued)

are swept along the plane creating the shape of the water storage unit on each plane. The shapes between these four planes are then blended together to complete the coffeemaker. This allows for a transition in shape along the vertical dimension of the water storage unit, permitting a variety of designs while ensuring integration of the filter, base, and water storage units. The grammar could be restricted to only the top and bottom planes or could be made more general by allowing more transition planes.

A significant aspect of the individuality of the design stems from parametric rules 45–90. Figure 8 shows that for each rectangular shape the side dimensions are specified and for each circular shape the diameter is specified on each plane; the distances from the center of the filter or base units are also specified. Again, these parameters must satisfy the restrictions mentioned above within each transition plane. The top view is specified through the addition of an arbitrary number of parametric rectangles and circles (rules 47–70) and a template shape for the grate on the top if one exists (rules 45 and 46). The resulting rectangles and circles on each plane are labeled  $x_1, x_2, x_3,$  or  $x_4,$  appropriately, except for the grate which is labeled G. Rule 44 is used in lieu of rules 45 or 46 if a lid is desired rather than a grate. Note that rules 44–46 are applied only to the top plane, providing an opening through which water is poured into the coffeemaker. Note that separate labels are associated with shapes on separate planes to ensure that shapes from one plane do not merge with those from another.

The actual shape of the unit is specified by parametric sweep rules 71–90 and merge rules 91–100. On each plane, each rectangle and circle can be swept in an arc or as a straight tangent from the center. As the section sweeps, the width ( $h$ ) and depth ( $d$ ) in case of rectangular sections and the diameter ( $r_0$ ) in case of circular sections as well as the distance from the center ( $r$ ) are allowed to vary through designer-specified functions ( $f$ ). Two functions are specified for each plane of the unit, one for a positive sweep from center and one for a negative sweep. The straight sweeps are specified as:

$$d, h, r_0 = f(z),$$

where  $z$  is the position of the positive or negative sweep, and arc sweeps are defined as:

$$d, h, r, r_0 = f(\phi),$$

where  $\phi$  is the clockwise or counterclockwise sweep.

As each sweep is performed, the labels are changed to  $x'_1, x'_2, x'_3,$  or  $x'_4,$  appropriately; after the grate is swept its label is removed and its shape is hashed. Each plane cross section is then formed by considering the envelope of the sweep of the remaining shapes by iterative application of rules 91–100; rules 95–100 also merge the water storage unit into the filter and base. Note that the grate is not merged with any other section. The cross sections on each of these planes must be blended vertically between the planes through designer-specified surfaces (the method for blending is beyond the scope of the grammar; smooth blends are assumed).

This set of rules generates a wide variety of coffeemakers. More details can be specified with additional rules. More restriction on permissible shapes can be asserted by limiting the freedom of choice of the parametric functions. As will be seen in the following sections, this language describes many coffeemakers available in

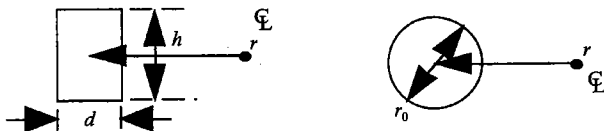


Figure 8. Parametric variables for rules 45–90.



the market as well as many styles not yet available to consumers. Owing to the parametric nature of the grammar, an infinite number of different designs can be generated.

#### 4 Example: generating coffeemaker designs

The coffeemaker shape grammar is now used to generate a complete design through straightforward application of the rules (figure 9, see over). The design is chosen to be a single-heater unit indicated by the label  $\square$  selected by rule 1 [figure 9(a)]. The initial shapes of the filter and base units are now generated via rules 3–5 [figure 9(b)]. We choose a simple side view cross section by specifying many of the points to be coincident.

Next the filter unit is designed. Functional rules 6, 7, 9, 11, 12, and 15 are applied to the unit and the following labels are associated with it:  $FM_1$ ,  $FT_1$ ,  $FI$ ,  $FF_1$ , and  $FS_2$ . Thus the filter unit has a sliding conical filter, with a fixed flow rate and no mechanism to stop the coffee flow. Function-to-form rules 16, 17, 18, 20, 22, 23, and 26 generate the filter unit shown in figure 9(c).

The base unit is then generated by using rules 27, 29, and 31. The shape, both at the top of the base unit and at the bottom, is chosen to be a circle; the burner is also specified to be a circle [figure 9(d)]. As this is a single-heater model, tubing is added to the base unit to bring water to and remove it from the heating element (rule 31). The top and bottom of the base are joined by a smooth surface generating a cylindrical base unit.

The functionality of the water storage unit is then designed with rules 38, 40, and 41. Label  $WF_2$  is added to indicate that the unit has a grating at the top to pour in water. The resulting right-most side of the center cross section of the water storage unit is shown in figure 9(e). The final shape of the water storage unit around the filter and the base is then designed. The section around the filter (the top) is generated first by adding a square for the water grate (rule 46) and then sweeping in a straight tangent (with rule 87). The top two transition planes are kept identical with a square for the top view of the unit specified by rules 48 and 50 and then sweeping them in straight tangents (rules 71 and 75) as illustrated in figure 9(f) (both planes are illustrated; the left-hand one also contains the grate). The shape around the base is also generated by sweeping two squares on identical planes [rules 52, 54, 65, 69, 79, and 83, resulting in figure 9(g)]. The final shape of the water storage unit is obtained by joining the sections between the transition planes by straight planes. The complete coffeemaker is illustrated in figure 10 (see over).

#### 5 Discussion and concluding remarks

The coffeemaker in figure 10 is similar to the Black & Decker model shown in figure 1(b). As a matter of fact, each of the coffeemakers shown in figure 1 are generated by our grammar, as can be seen in figures 10 and 11. Although each of these units may appear to be unique, small changes in the application of the rules of this grammar and the selection of the parametric values are the only real differences in their shape characteristics. As mentioned in section 3, an infinite number of coffeemakers can be generated with this grammar. Three designs generated by the grammar that are different from those in the market are shown in figure 12. Of course, shape is not the only contributor to design quality and appearance. Choice of material, control unit, color, and finish all affect the final product. However, many of these features could be included within an extended grammar. For example, color can be associated with the design through color grammars (Knight, 1989).

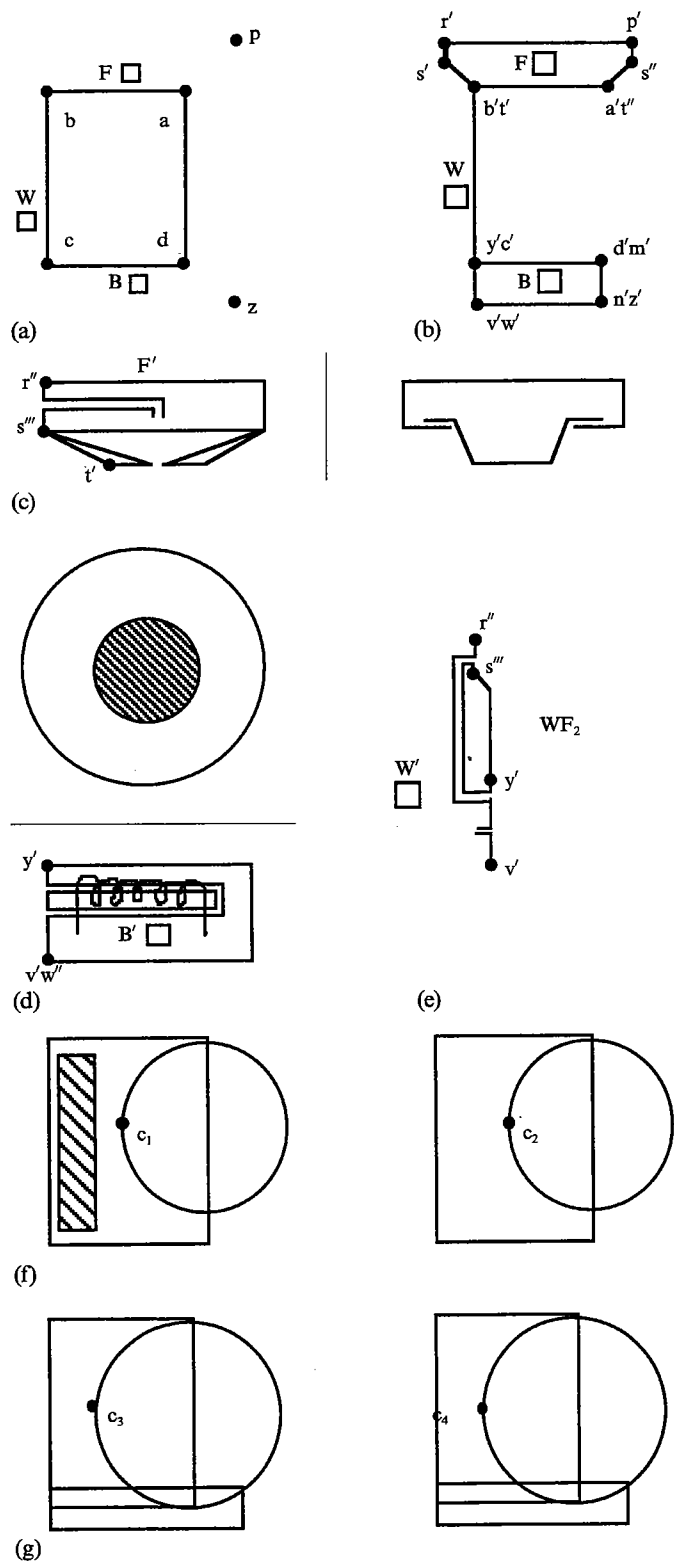


Figure 9. Example of a design generated in sequence by means of the shape grammar rules.

