



Presents



*How Toyz journey and our story pioneering the intersection of hip hop and technology
How it inspired my 10 year old son to become an engineer and get to Carnegie Mellon University and CNBC at 15.*

The Hustlenomics Way- From 2002 till now



2002

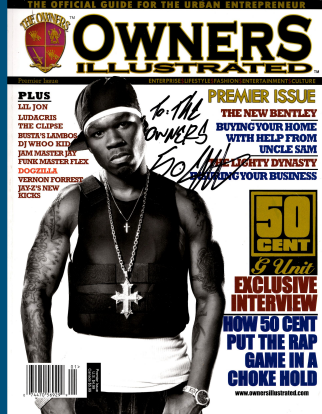

2003



2005



2007

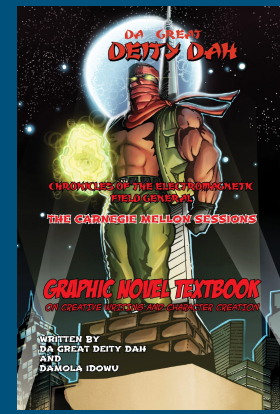

2019



2020

The entrepreneurial way you overcome systemic barriers to fulfilling your life purpose with happiness

Superhero Creators of the Future- TOYZSTEAM



Da Great Deity Dah- Engineer, Creative, Entrepreneur

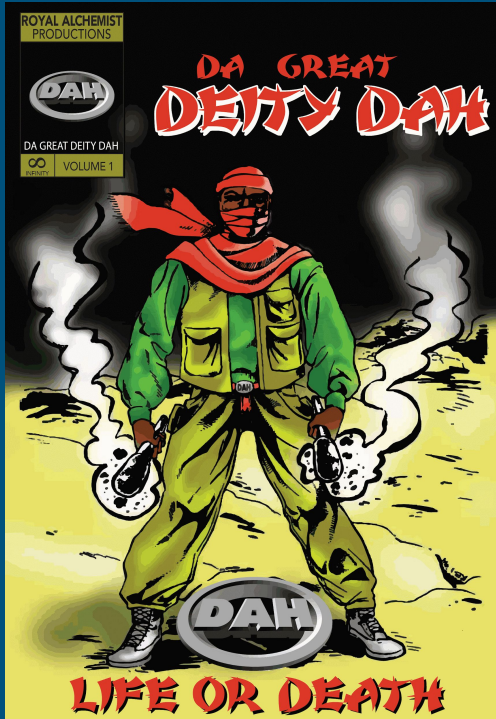

- *“Culture dictates Commerce”*
- *“A man gains immortality when his daily deeds and actions are worthy of dying for so when his body decays his soul shall remain everlasting”*
- *“The current system doesn't work for people that look like me so it required bold approaches that got the same outcomes desired but took a different route to get to the same destination”*

50 Cent- Supported first issue of Toyz



- “I think everybody should have a five-year plan – make short-term goals and long-term goals. I had created a plan for all the situations and kind of thought out different scenarios so I would be prepared for these situations when they came.”
- “If there are four things that make a star, I’d say its quality material, performance, appearance, and personality and if you lack in one of those areas you’ve got to pick up the slack in one of those areas. I just think that me being who I am and being comfortable enough to be who I am, allows me to place myself on a level that they can’t get to right now.”
- “...I just look at every opportunity and option that opens up for me and I feel that I can go somewhere and accomplish things that people didn’t think was possible. They asked me am I’m a role model and I said I’m not sure if I’m a role model, but I’m sure I’m inspiring”
- https://youtu.be/VtQNHw_biGk

Building Toyz Nation a community



Soul Aurum Design a TOY

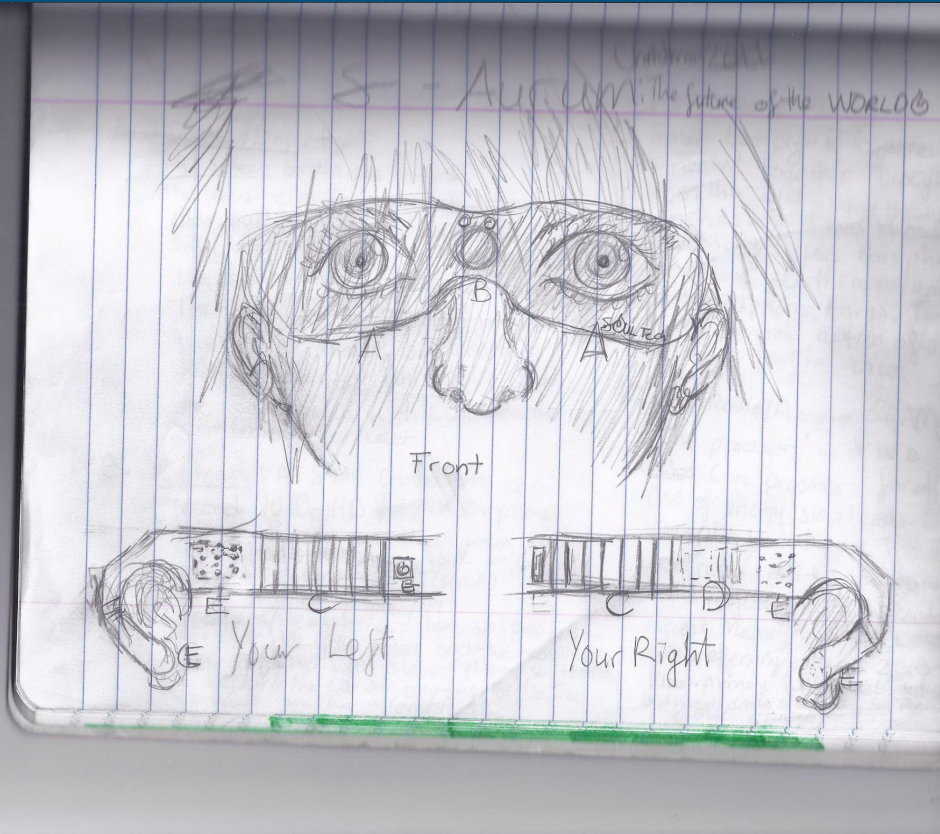

- *Featured Cars Gadget and Video Games*
- *Wole would sketch solar panels on consumer electronic products I reviewed*
- *He would come up with a concept for self powered smart glasses*
- *We will pitch this idea as the central piece of his college application and Thiel Foundation pitch on CNBC*

Soul Aurum Engineering

Soul Aurum SELF-POWERED SMARTPHONE GLASSES

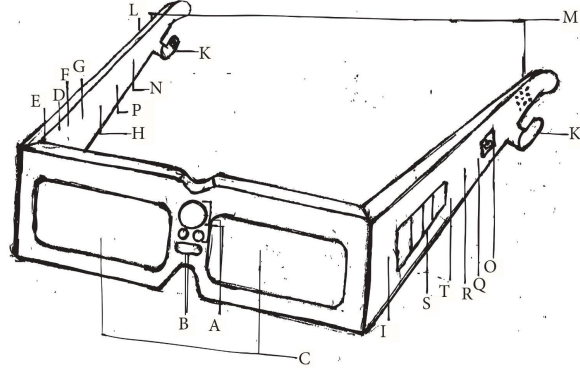

- A: 12 Megapixel Camera w/ Dual Flash
- B: Built-in projector
- C: Lenses & Screen using Dyed Sensitized Solar Cells
- D: ARM M0+ Chipset
- E: POWERVR GPU
- F: RAM
- G: 4GB Flash Memory
- H: Micro SD Card Slot
- I: 3.5mm to USB Charge/Sync Port
- J: Lithium Ion Battery
- K: Built in Earphones
- L: Microphone
- M: Speakers
- N: Alloy with solenoid to generate electricity from heat (Ni45Co5Mn40Sn10)
- O: Power Button
- P: GSM/EDGE/LTE/ UMTS/HSPA/HSPA+/DC-HSDPA Global Antenna
- Q: Assisted GPS
- R: Bluetooth 4.0
- S: Touch Sensitive Control Buttons
- T: Wi-Fi WMM PowerSave IEEE 802.11e

A. The Screen/Projector

HD screen on the side towards the users eyes. To navigate the OS user could use voice or move hands in front of camera (B) and it would be the same as moving finger on touchscreen. The images can be projected from each lens of the glasses and create a holographic display which also could be controlled with hand, interactive controlling for user.

B. Camera: An 8 MP Camera that can record 1080p HD Video. When phone is first turned on, the camera will scan hands which will be for security and navigation (see A)

E. Speakers/Headphones - There are speakers on each side of the glasses and the headphones are attached with clever system so it could be put in the ear at any time. Best of the speakers and the microphones.

C. Batteries

C. Solar battery & Batteries connected together through lens. This will charge the whole phone. This allows those without electricity to use this phone and have all the opportunities a smartphone brings. There also is the alternate option of a charger just in case.

D. 4G Radio/Processor & RAM + Memory

The processor will be a Quad Core processor for efficient use of energy since tasks will be split for each core. With the processor would be the 4G radio inside, preferably LTE. The Random Access Memory will be DDR2 and preferably at least 2GB-4GB. Flash Memory will be about 4GB but most data stored via satellite cloud storage.

Wole on CNBC Documentary at 15

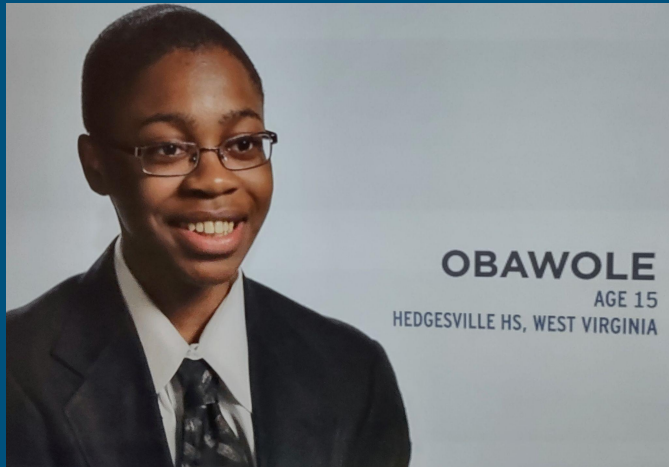
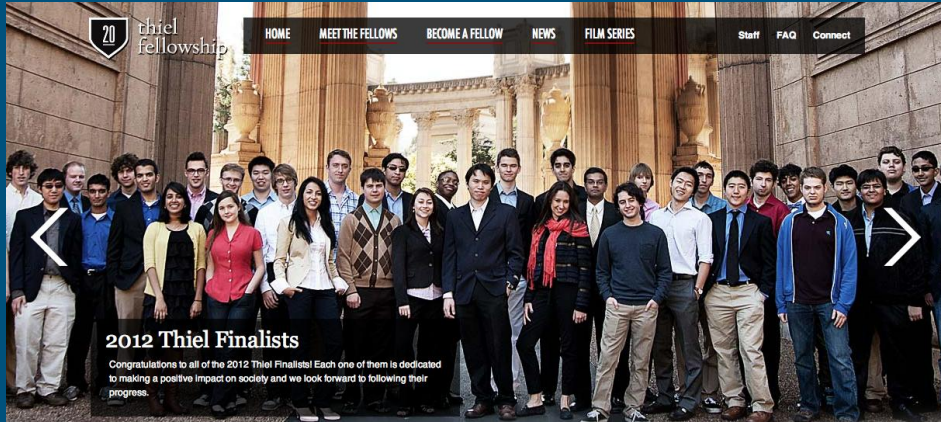

eSPORTS Epic Games and EA



On a nice autumn evening in Raleigh, NC hundreds of Gears fans descended on Ess Lounge in downtown Raleigh, and enjoyed an experience of a lifetime as they got to enjoy the fruits of a partnership between the International Game Developers Association, Toyz Nation and Epic Games Studios. Starting at 7pm the event featured a distinguished panel with Mike, President of Epic Games, Colin Deans Project Manager of Epic Studios, and Alexander Marcus CEO of Themis Group all providing local students from area colleges like Wake Tech, NCSU, UNC, Duke, and other on the in's and outs of the gaming industry. Topics of the panel included portfolio submissions, to courses to take, to current climate in the industry, to even how to form their own game development company. Students were very attentive and asked great questions which will be helpful for their careers. After the panel the student gamers became the envy of Gears fans worldwide they got to play Gears 2 with members of the development team at Epic before the worldwide release. How Cool!! Dana Crowley from Epic was also on hand to give away really cool prizes like autographed copies of the limited edition Gears comic book, novel and posters. After giving everyone a chance to get some practice the real fun began with the first ever official Gears 2 tournament in the Triangle area. 5 teams of 5 played in Horde mode beginning in Wave 10 with the objective to get thru as many waves as possible. Only one group got thru to Wave 11. I got a tip from a source who had informed me that if everyone had begun on wave one and got thru the level then on Wave 8 you could have got the grinder which would have made Wave 10 easier. That screw easy Toyz Nation was giving away a \$100 footlocker gift certificate, Skull Candy Headphones, Marvel Comics T-shirts, and Dana was giving away the Gears Branded Zane Player, a collectors edition of gears, and autographed posters. Everyone had a blast and played and partied beyond 2AM. In terms of Gameplay by the way look forward to my review but the graphics and the improvement on the Unreal 3 engine are outstanding. The event went so great we are now going to do a weekly night with Ess lounge centered around gaming and music so stay tuned. Thanks to all event partners including Nick from Ess lounge who was more than a gracious host. Also check gears2war.com, and IGDA.org to catch more pictures from the event than what's below.



24 • TOYZNATION.COM

IGDA PRESENTS THE TOYZNATION.COM
Getting Into The Gaming Industry & Gears of War 2 Launch Party

- Network from 7:00 p.m. - 10:00 p.m.
- Countdown to the Gears of War 2 worldwide release from 10:00 p.m. - 12:00 a.m.
- Participate in the Triangle's first Gears of War 2 tournament, which will run from 12:00 a.m. - 2:00 a.m.
- Enter to win swag like Marvel Comics T-shirts, Skull Candy headphones, a \$100 Foot Locker gift certificate, autographed Gears 2 posters and more. Plus, the grand prize winner will be featured as a character in a comic book and appear in Toyz Magazine.

Don't just game for fun - game for fun!
Hear from top execs at local studios like Epic Games, Themis Group, and more at this breaking into the industry event, co-hosted by the International Game Developers Association (IGDA), www.igda.org

Ladies FREE all night
Guys FREE from 7-10pm
Guys under 21 \$10 after 10pm
Guys 21 and over \$5 after 10pm

www.myspace.com/gears2war2event
www.igda.org
www.toyznation.com

MADDEN NFL 09
TOYZNATION.COM
GameStop
GO TO WWW.TOYZNATION.COM TO REGISTER & PURCHASE TICKETS

EA SPORTS

THE TOYZNATION.COM MADDEN NFL 09 TOURNAMENT

EVERYONE E
NFL PLAYERS

COME OUT AND PLAY! WIN CASH AND PRIZES!

THE PRESEASON
August 20, 2008
GameStop - Gallery S. Dekalb
2801 Candler Road
Decatur, GA 30034
(404) 243-5516

THE MAIN EVENT
August 23, 2008
Georgia International Convention Center
2000 Convention Center
College Park, Georgia 30337



Traveling from as far as New England territory Hartford Connecticut to the swamps of Gainesville Florida, the Toyz Nation Road Show and Expo was a successful series of Madden 09 Tournaments and video gaming experience in partnership with Gamestop that highlighted the best in humanity and illustrated the impact gaming can have on human life. Several touching storylines developed like one of a father and son who both entered a tournament and the father not wanting to play against his son (feeling before he realized that to have his son win he had to defeat the other opponent, the son wound up redeeming the father and doing the family proud. People from various races and ethnicities also competed as Latino's, Blacks, Whites, and Asians. Old, young, children, parents, friends all came and played video games. Parents could tell the words, but behind the images are stories of cross town rivalries, passionate gamers, strategies, and the "unfair" advantage of using Brady and Moss with the New England Patriots. There was tons of fun and excitement and great prizes including premium head phones by Skull Candy, gift cards from Gamestop and Footlocker, opportunities to be immortalized in print and even animated in a comic book. At the expo at the Georgia International Convention Center, we had a mother bring her four adorable daughters to play Gta:ta Hero, and Rock Band, which also was played by Candace Cabrera of Flavor of Love 3 Fame. We had fathers bring their sons, we had passionate madden gamers camp out before the doors opened eager to get into the competition. Gaming is more than just recreation for "kids" It's a social experience that encourages friendship and fellowship between people from all backgrounds, and provides an outlet to let creativity foster. We had a distinguished panel of interactive media developers, Game developers and a state of Georgia representative, the panel included: Joseph Sautler, Danny Miller, Asante Bradford, Kevin O'Gorman, and Andrew Greenberg who spoke about opportunities for careers in gaming, and new developments in the gaming world and how the state of Georgia is poised to become a big player with a big 30% tax incentive created to lure companies to set up studios there. We had tremendous support from Gamestop management and look forward to taking the expo on the road with our college tour, DC Holiday event, and massive Super-bowl event at the GLI Complex in Charlotte city in Tampa, Florida. Keep-checking www.toyznation.com for more information.



22 • TOYZNATION.COM

Superheroes in a Hip Hop Metaverse

Real time 3D based on actual characters of the esports players and models and influencers who cheered them on

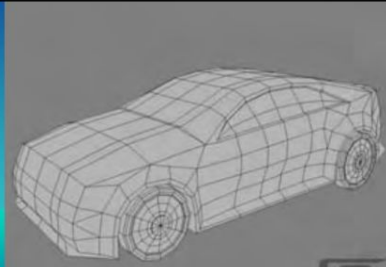
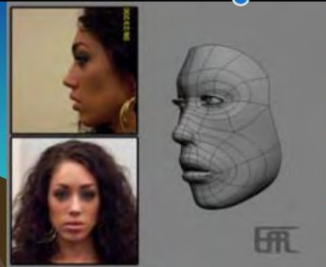
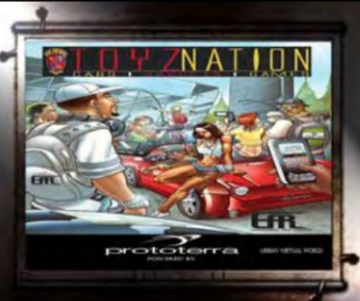

Madden Athletes as Avatars



EA
MADDEN NFL 09
15 YEARS

GameStop
power to the players
TOYZ NATION

The Preseason
Aug. 17, 2008
12:00 pm - 6:00 pm
GameStop
Prospect Plaza Unit A
18 Kane St
Hartford, CT 06101
(860) 570-4873

EA SPORTS

THE TOYZ NATION.COM
MADDEN NFL 09
TOURNAMENT

EVERYONE
E
CONTENT RATED BY
ESRB

FOR MORE INFO, GO TO
WWW.TOYZNATION.COM

NFL PLAYERS

COME OUT AND PLAY! WIN CASH AND PRIZES!

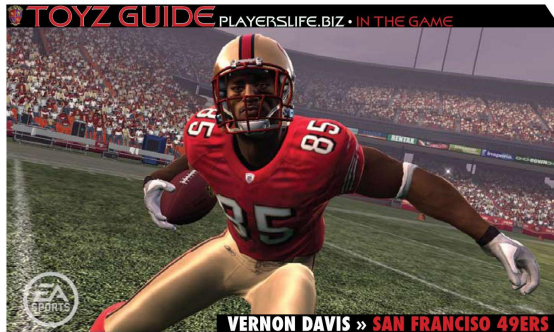

Since becoming the sixth draft pick of the San Francisco 49ers 3 years ago Vernon Davis has shown amazing potential to become one of the league's elite tight ends. His physical gifts are unbelievable as he has 4.3 speed paired with his size which poses a match up problem for any line backer or safety. Great genes also run in the family his younger brother Vontae Davis plays cornerback for the Fighting Illini of the University of Illinois and is projected to be an even bigger prospect in the NFL. Vernon this summer put together an All star charity weekend which brought people like Nisey Nash, and Melissa Ford, Too Short, and Candace "Black" Cabrera to support "I reached out to a lot of people. I told them I'm having a charity weekend. They all decided to come out and support. I like giving back." Vernon had told us. What was most impressive to me however was the brunch he hosted along with members of DC Sports Commission, and Council persons from the various DC wards, who came and presented an award to Vernon for his service, and would partner with him on future endeavors to encourage at risk DC youth. We wish Vernon the best in his out reach endeavors.

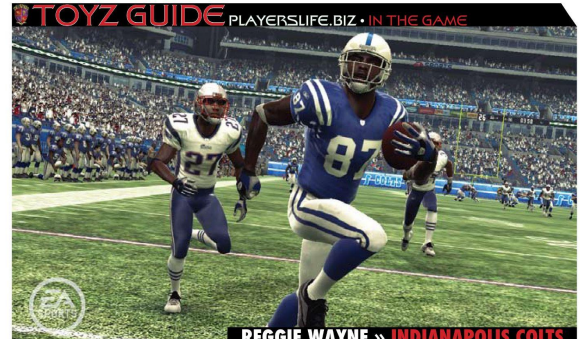
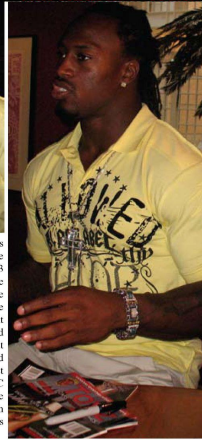

Over the past 3 years Reggie Wayne has studied under future Hall of Famer Marvin Harrison and developed into Payton Manning's favorite target and one of the best receivers in the league. Last year he lead the league in yards and receptions and this year he remains among the leaders and has made spectacular play after another in the turnaround of the Colt's season that has them poised for a strong run at another Championship this year. We caught up with him at Santana Moss's birthday weekend/Charity event. Where he spoke to us about the "brotherhood of he U" "I'm in here representing in DC for my man, Tiana, man, it's his birthday. I'm out here showing love 'cause that's my dog. We are out here just having fun... It's a brotherhood, man. That's all you got to say. Once you say the U, you put that U up, it's a brotherhood. We live by, die by that, all day, everyday. Whenever somebody from the U is doing something we all show him love and support." Well said.



Ralph Gilles- Head of Design, Fiat Chrysler Automobiles N.V.



<https://media.stellantisnorthamerica.com/newsrelease.do?id=2123>

- *“Fast Five was incredible, watching our cars kind of be heroes, ... It’s a very clever way to show the cars in a heroic way.”*
- *“I have a very competent design office. I can’t do everything, right, so obviously I’ve got a great team of people.... I’ve got one designer for every brand. ”*
- *“Chrysler's been really good to me from the minute I joined in '92 until now. I never once suffered any kind of racism or anything. It's been the opposite. They've always thrown me in the deep end of the pool, said go swim. Go for it. See your vision out. See your passions out so that's been great and I do a lot of speaking”*

Henrik Fisker- Chairman & CEO at Fisker Inc



- "green cars can be good looking sexy, fast, and big... its important to make a statement about getting a green car that's exciting enough that you want to own this car, that you want to buy it"
- "We got solar panels on the roof and that can give you up to 2000 miles a year. Nobody has really done solar panels where you actually can charge the high voltage battery, so, we can do this for this vehicle"
- " we did a lot of cool stuff, like really wide track large 22 inch wheels. You can also get 20 inch wheels if you want to go a little more off-road, but the design was very important for me to really get this sort of sports car feeling into an SUV, because nobody's really done before."
- "if young people can come up with the next generation of super sustainable vehicles which still looks good. You know, we had this issue with electric cars when they first came out, they kind of looked doey and dorky, and nobody wants to drive a dorky car. So, whenever you think about a new futuristic design, it needs to look good, it needs to be exciting, it needs to be better than what we have today."
- <https://youtu.be/MAIHstFuTn8>

<https://www.linkedin.com/in/henrikfiskerofficial/>

Earl Lucas- Chief Exterior Designer, Lincoln



- *Regarding interiors he said, “The interiors are brand new too...Like mama used to say, it’s not just the outside that counts....On the inside it’s much more like a Mustang feel...It creates a unique space for the occupant.”*

. “These cars are going to be with us for some time to come so they need to be graceful....In a couple years the shape will still be relevant. The shape will still be beautiful,”

- *“The number one key is the ability to sketch and be able to create your ideas so that others could enjoy it....The biggest advice to give anyone who wants to be a car designer is to love to draw.”*
- <https://youtu.be/NZLZhInwSto>

Bill Giese- Design Architect at Turn 10 Studios



- *“we get all the CAD data so when we build our car we have this process called body and wipe. We get the base mold from the manufacturer. We get all of the data that they get from the dynos and all their engine stuff and we run that through our physics system”*
- *“we start a new product, we want to find a great partner and we want to make sure that we’re able to highlight and show off the car in a very special and unique way. And so, we really try to do it as early as possible so that we can”*
- *“So, I dropped out of college. I went to work at Nintendo to answer phones before the internet of big things. The biggest thing I’ve learned more than anything is, if you love what you do and you work hard, you can do whatever you want”*

<https://www.linkedin.com/in/bill-giese-4821a718/>

Roy Harvey-VP Mobile, Technology and Innovation EA



- *“Actually think the humanities is probably one of the most important areas for games moving forward”*
- *“The UI and you think of it like a second or second class citizen, but it's really first and foremost of the whole experience.”*
- *“you're competing with everybody else who has an entertainment experience and you're competing for time... If you create friction To that experience, you make the game way too hard to get into, way too hard to navigate, way too hard to understand people are just going to drop out”*

<https://www.linkedin.com/in/harveyroy/>

Lil Wayne - Artist, Entrepreneur



- *“Personally, I’m a hustler and you can’t let tragedy touch you at all if you’re a hustler...”*
- *“Let me tell you something, a hustler never worries about what you lose.”*
- *“Only time you got to dwell on the past is when it’s great history.”*
- *“my devotion to what I do, creativity, man...it’s the perfect definition of who I am.”*

Contact Me



Damola Idowu

CEO

Toyz Electronics

A Carnegie Mellon University Startup

at the Swartz Center for Entrepreneurship

Toyzelectronics.com

www.toyzsteam.com

4620 Henry St

Pittsburgh, PA 15213

202-607-3629

damola@toyzsteam.us

<https://www.linkedin.com/in/owners-illustrated/>

<https://toyznation.com/training-for-the-automotive-jobs-of-the-future/>

THANK YOU!